

# ***Color Video Printer***

---

Instructions for Use



**UP-20**  
**UP-21MD**

## Owner's Record

The model and serial numbers are located at the rear. Record these numbers in the space provided below. Refer to these numbers whenever you call upon your Sony dealer regarding this product.

Model No. \_\_\_\_\_



Serial No. \_\_\_\_\_

### WARNING

To prevent fire or shock hazard, do not expose the unit to rain or moisture.

To avoid electrical shock, do not open the cabinet. Refer servicing to qualified personnel only.

### THIS APPARATUS MUST BE EARTHED.

	This symbol indicates the equipotential terminal which brings the various parts of a system to the same potential.
	This symbol is intended to alert the user to the presence of important operating and maintenance (servicing) instructions in the literature accompanying the appliance.

### For the customers in the U.S.A.

This equipment has been tested and found to comply with the limits for a Class A digital device, pursuant to Part 15 of the FCC Rules. These limits are designed to provide reasonable protection against harmful interference when the equipment is operated in a commercial environment. This equipment generates, uses, and can radiate radio frequency energy and, if not installed and used in accordance with the instruction manual, may cause harmful interference to radio communications. Operation of this equipment in a residential area is likely to cause harmful interference in which case the user will be required to correct the interference at his own expense.

You are cautioned that any changes or modifications not expressly approved in this manual could void your authority to operate this equipment.

This device requires shielded interface cables to comply with FCC emission limits.

### For the customers in Canada

This unit has been certified according to Standard CSA C22.2 NO.601.1.

## Important safeguards/notices for use in the medical environments

1. All the equipments connected to this unit shall be certified according to Standard IEC60601-1, IEC60950, IEC60065 or other IEC/ISO Standards applicable to the equipments.
2. When this unit is used together with other equipment in the patient area\*, the equipment shall be either powered by an isolation transformer or connected via an additional protective earth terminal to system ground unless it is certified according to Standard IEC60601-1.

\* Patient Area

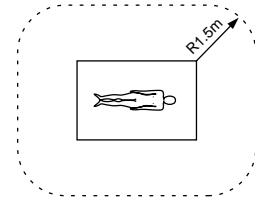

3. The leakage current could increase when connected to other equipment.
4. This equipment generates, uses, and can radiate frequency energy. If it is not installed and used in accordance with the instruction manual, it may cause interference to other equipment. If this unit causes interference (which can be determined by unplugging the power cord from the unit), try these measures: Relocate the unit with respect to the susceptible equipment. Plug this unit and the susceptible equipment into different branch circuit. Consult your dealer. (According to standard EN60601-1-2 and CISPR11, Class B, Group 1)

### Caution

When you dispose of the unit or accessories, you must obey the law in the relative area or country and the regulation in the relative hospital.

### Warning on power connection

Use a proper power cord for your local power supply.

### Warning on power connection for medical use

Please use the following power supply cord.

With connectors (plug or female) and cord types other than those indicated in this table, use the power supply cord that is approved for use in your area.

	United States	Canada
Plug Type	HOSPITAL GRADE*	HOSPITAL GRADE*
Female end	E62405, E35708	LR53182, LL022442, LL088408
Cord type	E159216, E35496 Min. Type SJT Min. 18 AWG	LL112007-1, LL20262, LL32121, LL84494 Min. Type SJT Min. 18AWG
Minimum cord set rating	10A/125V	10A/125V
Safety approval	UL Listed	CSA

\*Note: Grounding reliability can only be achieved when the equipment is connected to an equivalent receptacle marked 'Hospital Only' or 'Hospital Grade'.

---

# Table of Contents

---

## Introduction

<b>About This Manual</b> .....	4
<b>System Overview</b> .....	4
<b>Location and Function of Parts and Controls</b> ....	5
Front Panel .....	5
Rear Panel .....	6
Monitor Display .....	7

---

## Preparation

<b>Supplied Accessories</b> .....	9
<b>Connections</b> .....	10
Connecting Video Equipment .....	10
Connecting the Video Monitor .....	11
Making Connections to Enable Remote Control ..	12
<b>Before Printing</b> .....	13
Loading an Ink Ribbon .....	13
Loading Paper .....	14
Selecting the Input Signal .....	15

---

## Operation

<b>Making Full-Size Image Printouts</b> .....	17
Making Printouts with the Desired User Set	
Number .....	19
Making Multiple Copies of Identical Printouts	20
Capturing Another Image While Printing .....	22
<b>Making Variations of Printouts</b> .....	23
Selecting the Memory Mode .....	23
Selecting a Memory Page .....	24
<b>Making a Printout of Multiple Different Reduced</b>	
<b>Images</b> .....	25
<b>Making Printouts With a Caption</b> .....	31
Entering a Caption .....	31
<b>Deleting Images Stored in Memory</b> .....	35
Setting the Function of the CLEAR Button .....	35
Deleting Images Stored in Memory .....	35
<b>Erasing the Screen Display on the Video Monitor</b>	
36	

---

## Adjustment

<b>Functions That Can be Set on Menus</b> .....	38
<b>Menu Tree</b> .....	39
<b>Basic Menu Operations</b> .....	40
<b>Adjusting the Color and Picture Quality</b> .....	43
Compensating for the Input Signals .....	43

Matching the Video Monitor Color to the Printer	
Color .....	44
Adjusting the Printout Color .....	45
When a Black Frame or Lines Show up on the	
Printouts .....	47
Adjusting the Color Balance .....	48
<b>Making Various Settings</b> .....	52
Assigning Functions to the Remote Control Unit .	
52	
Adjusting the Brightness of the Printer Window	
Display (Only for the UP-21MD) .....	53
Selecting Whether the Operation and Error Tones	
Sound .....	53
Setting the Baud Rate .....	54
Displaying the Type and Remaining Amount of	
the Ink Ribbon .....	54
Registering a User Set .....	54

---

## Miscellaneous

<b>Precaution</b> .....	56
Safety .....	56
Installation .....	56
Before Transporting the Printer .....	56
Cleaning .....	57
<b>Recommended Ink Ribbon and Paper</b> .....	57
<b>Specifications</b> .....	58
<b>Error/Warning Messages</b> .....	61
Error Messages .....	61
Warning Messages .....	62
<b>Troubleshooting</b> .....	63
If Damage is Suspected .....	63
If the Paper Jams .....	64
<b>Index</b> .....	65

# About This Manual

This manual covers the following UP-20 series color video printers.

- UP-20
- UP-21MD

Wherever the operation or any other item differs between the models, this manual clearly describes those differences.

The difference among models is as follows:

Model	RGB SYNC connector	Printer window display
UP-20	No	No
UP-21MD	Yes	Yes

In this manual, the UP-21MD is used for illustrations. However, only the video monitor display is used to explain the operation of the unit except in the case where the printer window display is required such as for instructions on basic menu operations. For customers who are using the UP-21MD, see “Basic Menu Operations” on page 40 for a detailed explanation of the printer window display.

# System Overview

The UP-20/21MD is a color video printer that quickly and easily reproduces images from video equipment such as a VTR.

The UP-20/21MD has the following features:

- High picture quality and high print resolution  
The printer allows you to print out high resolution images in full color (with 256 shades per color, a total of more than 16,700,000 colors in all) in high resolution print mode (approximately 403 dpi).
- Menu settings according to your printer specifications  
By changing the menu settings for the printer, you can make various types of printouts. You can also add a caption to the printout. You can carry out ordinary printer operations using the buttons and you can set up the printer interactively by picking settings from displayed menus.

# Location and Function of Parts and Controls

For details, refer to the pages given in parentheses.

## Front Panel

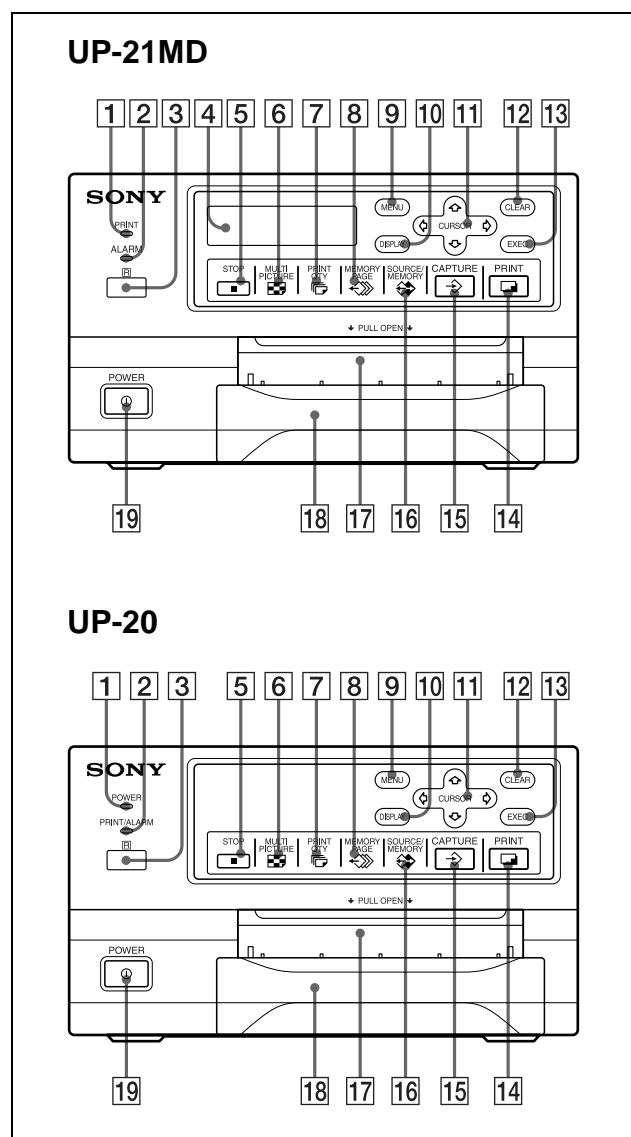

- 1 PRINT indicator (for the UP-21MD)**  
Lights while the printer is printing.
- POWER indicator (for the UP-20)**  
Lights in green while the printer power is on.
- 2 ALARM indicator (for the UP-21MD)(61)**  
Lights in orange when the ink ribbon or paper is exhausted, the paper jams, or another problem occurs.

**PRINT/ALARM indicator (for the UP-20) (61)**  
Lights while the printer is printing in green.  
Lights in orange when the ink ribbon or paper is exhausted, the paper jams, or another problem occurs.

- 3 Remote sensor (12)**  
Aim the head of the remote control unit toward this sensor.
- 4 Printer window display (only for the UP-21MD)**  
Displays messages that also appear along the bottom edge of the monitor screen. The printer window display has a narrower display range and shows only a limited number of characters. Also displays the menu screen line at which the cursor is positioned. If an error occurs, a corresponding error message is displayed.  
The contrast of the printer window display can be adjusted on the SYSTEM SETUP menu. (“Adjusting the Brightness of the Printer Window Display (Only for the UP-21MD)” on page 53.)
- 5 STOP button (18)**  
Press this button to stop continuous printing. The printer stops printing after finishing the printing item currently being printed.
- 6 MULTI PICTURE button (25)**  
Press this button to select the desired printout type on the regular screen. When you press this button, the currently selected printout type is displayed for a few seconds. Each time you press this button, the type is switched in the following sequence: 1, 2, 4, 1....  
The setting of MULTI PIX on the LAYOUT SETUP menu changes linked with the press of this button.
- 7 PRINT QTY (quantity) button (20)**  
Press this button to set the number of copies on the regular screen. You can set any number up to 9. When you press this button, the currently selected number is displayed for a few seconds. The setting of PRT QTY on the PRINTER SETUP menu changes linked with the press of this button. You can change the number even when the printer is printing.
- 8 MEMORY PAGE button (22, 25, 36)**  
Press to select the memory page.
- 9 MENU button**  
Press this button to display or clear the menus.

- 10 DISPLAY button (19, 36)**  
When the regular screen is displayed, pressing this button toggles the screen display of messages such as Q1, A, etc., on and off regardless of the setting of the DISPLAY item in the OUTPUT SETUP menu. The setting of DISPLAY in the OUTPUT SETUP menu changes linked with the press of this button. When the menu is displayed, pressing this button temporarily clears the menu display. While this button is held down, the menu display disappears.

- 11 Cursor keys**  
Use to select a desired item from the menu. Also, these keys are used to position the cursor (green pointer) on the regular screen when capturing multiple reduced images.
- 12 CLEAR button (35, 36)**  
Press this button to clear the images captured in the memory pages. Which images can be cleared with the CLEAR button depends on the setting made with the FUNCTION SETUP menu. When the clear function of this button is set to OFF, the buzzer sounds if you press the CLEAR button.

- 13 EXEC button**  
Press this button to execute the values set with the COLOR ADJUST menu or to load a user set in the PRINTER SETUP menu and to register the user set in the SYSTEM SETUP menu. Also, this button is used to enter the characters of a caption in the CAPTION menu.

- 14 PRINT button**  
Press this button to make a printout.

- 15 CAPTURE button**  
Press this button to capture an image in a memory page.

- 16 SOURCE/MEMORY button**  
Press this button to select which signal is to be output to the monitor. The memory image and source image are toggled each time you press this button.

- 17 Paper output slot**  
Printed pages (printouts) are ejected here. Depending on the curled condition of printouts, the printer may stop printing and display the message "REMOVE PRINTS." In such a case, remove the printouts accumulated on the paper tray. The printer will start to print the remaining copies automatically. When the UPC-21L printing pack is used, the ejected printouts are accumulated on the paper tray, but protruding from the tray. Do not

block this output slot. Doing so may cause the paper to jam.

- 18 Paper tray (9, 15)**  
Load paper into this tray.

- 19 POWER switch**  
Press this switch to turn the printer on or off.

## Rear Panel

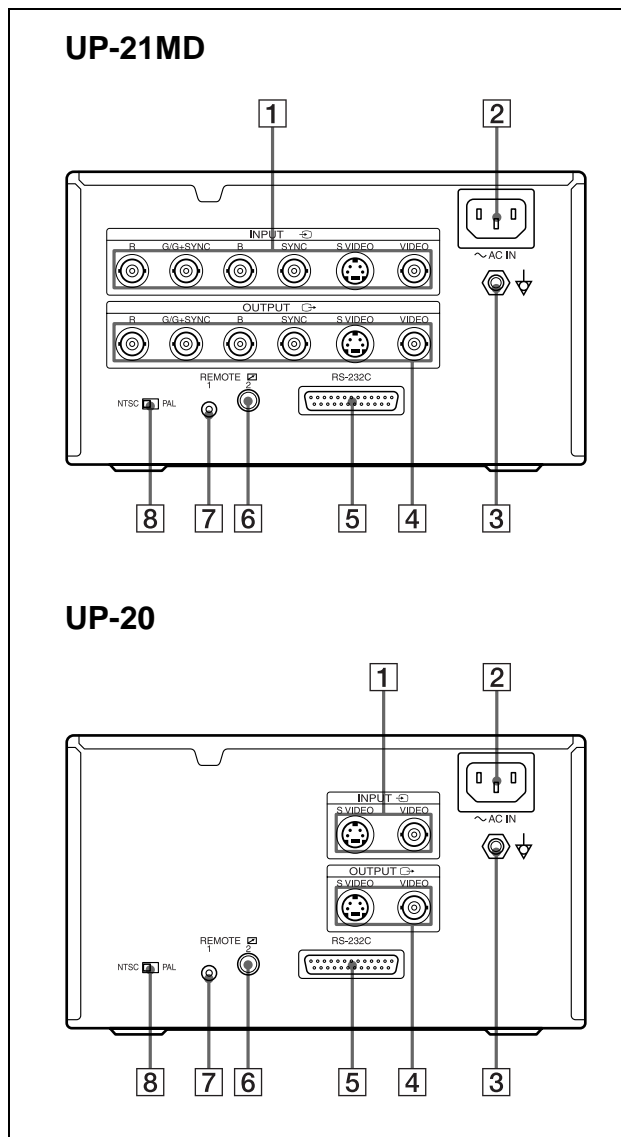



- 1**  **INPUT (input signal) connectors (10)**  
Used to connect the video equipment supplying the source image.

Connector	Connectable equipment
RGB SYNC <sup>a)</sup>	Video equipment with RGB SYNC output connectors
S VIDEO	Video equipment with a Y/C separated output connector
VIDEO	Video equipment with a composite video signal output connector

a) RGB SYNC connectors are equipped only with the UP-21MD.

- 2**  **AC IN connector (10, 11, 12)**  
Used to connect the printer to a wall outlet with the supplied power cord.

- 3**  **Equipotential ground terminal connector (10, 11, 12)**  
Used to connect to the equipotential plug to bring the various parts of a system to the same potential. Refer to “Important safeguards/notices for use in the medical environments” on page 2.

- 4**  **OUTPUT connectors (11)**  
Used to connect the video monitor.  
Refer to “Important safeguards/notices for use in the medical environments” on page 2.

Connector	Connectable equipment
RGB SYNC <sup>b)</sup>	Video monitor with RGB SYNC input connectors
S VIDEO	Video monitor with a Y/C separated input connector
VIDEO	Video monitor with a composite video signal input connector

b) RGB SYNC connectors are equipped only with the UP-21MD.

- 5** **RS-232C connector (12)**  
Used to connect a computer to control the printer.  
For details, contact your nearest Sony dealer.
- 6**  **REMOTE 2 connector (stereo mini jack) (12)**  
Used to connect a RM-91 Remote Control Unit (not supplied).
- 7** **REMOTE 1 connector (special mini jack) (12)**  
Used to connect an RM-5500 Remote Control Unit (not supplied) to be used as a wired remote control unit.

- 8** **NTSC/PAL (NTSC/PAL TV) selector (10, 11)**  
Set this selector according to the TV system of the input signal. If you change this setting, turn the printer power off, then back on again.

Selector position	When
NTSC	NTSC system video equipment is connected.
PAL	PAL system video equipment is connected.

## Monitor Display

When the printer is connected to the video monitor and you first turn on the printer, the following regular screen message appears.

When the MENU button is pressed, the menu screen displayed.

For detailed information on the menu screen, see “Menu Tree” on page 39.

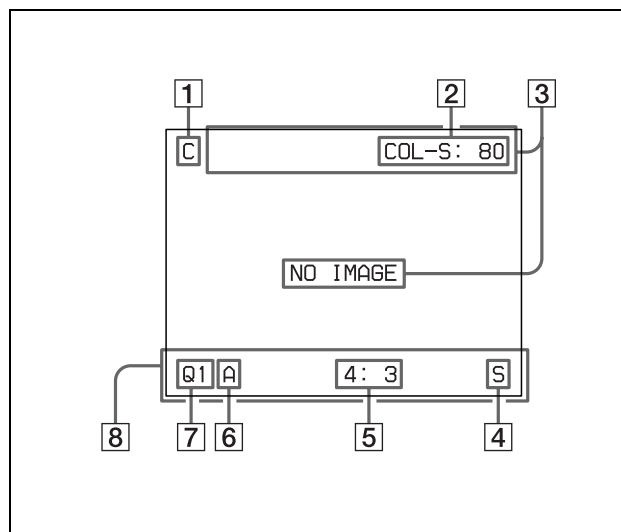

- 1** **C (Caption) display section**  
C is displayed in white when the printer is set to print a caption.
- 2** **Ink ribbon type and remaining amount of ink ribbon display section**  
Displays the ink ribbon type and the remaining amount of ribbon (indicates the number of printouts that can still be made with the ribbon) when the ribbon remaining display function is set to ON.
- 3** **Message display section**  
Messages are displayed.  
Error messages are displayed on the top line of the screen.  
Warning messages are displayed on the center of the screen.

- 4 S or M (image type) display section**  
Indicates the type of image being displayed on the monitor screen.  
S (Source): The image from the input signal source is displayed on the screen.  
M (Memory): The image captured in memory is displayed on the screen.

- 5 Printer operation mode display section**  
Indicates the printer operation mode (type of printouts such as multiple reduced images).

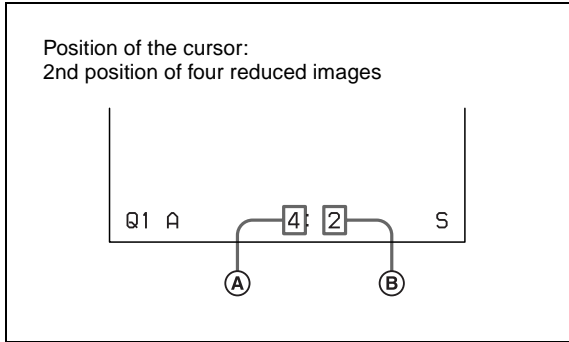

- (A) Type of printout**  
Indicates the type of printout.  
When SEPARATE (image with white borders) is set to ON on the LAYOUT SETUP menu, F is attached to the number in this position.
- (B) Position of the cursor**  
Indicates the position where the cursor is currently placed and where an image will be captured.

- 6 Memory page display section**  
Indicates the currently selected memory page. While the image in the memory page is being printed, the memory page indication blinks in white. The memory page whose memory image is queued to be printed blinks in white.
- 7 Q (print quantity) display**  
Indicates the number of copies to be printed. This item blinks while the printer is busy.
- 8 Printer setting status display section**  
The corresponding currently selected status is displayed when either MULTI PICTURE or PRINT QTY button is pressed.



# Supplied Accessories

The printer is packed together with the following accessories. Check that nothing is missing from your package.

Ink ribbon and paper <sup>a)</sup> (1)

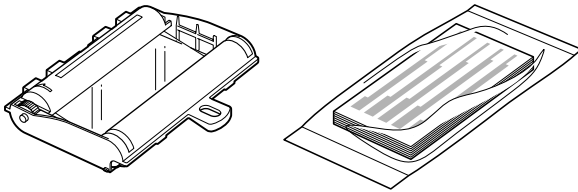

Paper tray (1)

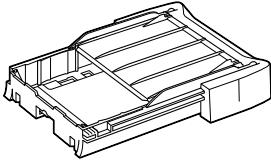

Power cord (1)

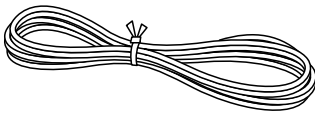

Warranty card (1) (for the customers in the U.S.A and Canada only)

CD-ROM (1) (for the customers in the Europe only)

Thermal head cleaning cartridge (1)

Instructions For Use (1)

a) Use the ink ribbon and paper for an operation check.

## Notes

- Retain the original carton and packing materials in case you have to transport the unit in the future.
- Remove the ink ribbon cartridge and paper tray when transporting the printer.
- When transporting the printer, secure the thermal head. (For detailed information on how to secure it, see page 56.)

# Connections

To enable printing, video equipment to act as an input signal source, and a video monitor to display images or menus must be connected.

The following diagrams illustrate how to make the input, output and remote control connections. Use this as a guide when connecting the cables required to transmit signals to and from the equipment to be used for printing.

## Notes

- Turn off the power of each device before attempting to make any connections.
- Connect the AC power cord last.

## Connecting Video Equipment

Connect the video equipment providing the video images to be printed.

Connect the video equipment which will be used in actual printing, using the following diagram as a guide. Before connecting the video equipment, see “Important safeguards/notices for use in the medical environments” on page 2.

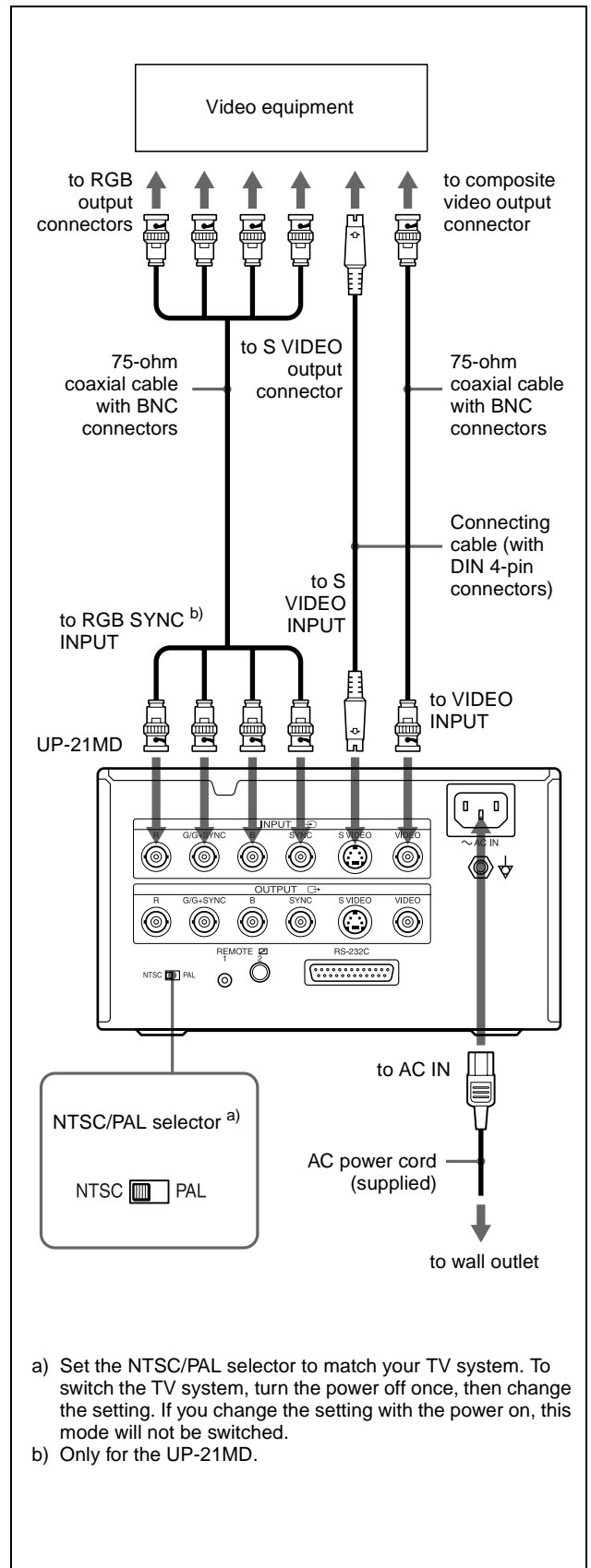

a) Set the NTSC/PAL selector to match your TV system. To switch the TV system, turn the power off once, then change the setting. If you change the setting with the power on, this mode will not be switched.

b) Only for the UP-21MD.

## Connecting the Video Monitor

Connect a video monitor to view captured images and to check those to be printed. Connect a suitable video monitor which will be used in actual printing, using the following diagram as a guide.

Before connecting the video equipment, see “Important safeguards/notices for use in the medical environments” on page 2.

### When connecting the video monitor only to the RGB OUTPUT connectors (only for the UP-21MD)

When connecting the video monitor only to the RGB OUTPUT connector without connecting to SYNC connector, set SYNC ON G in the OUTPUT SETUP menu to ON.

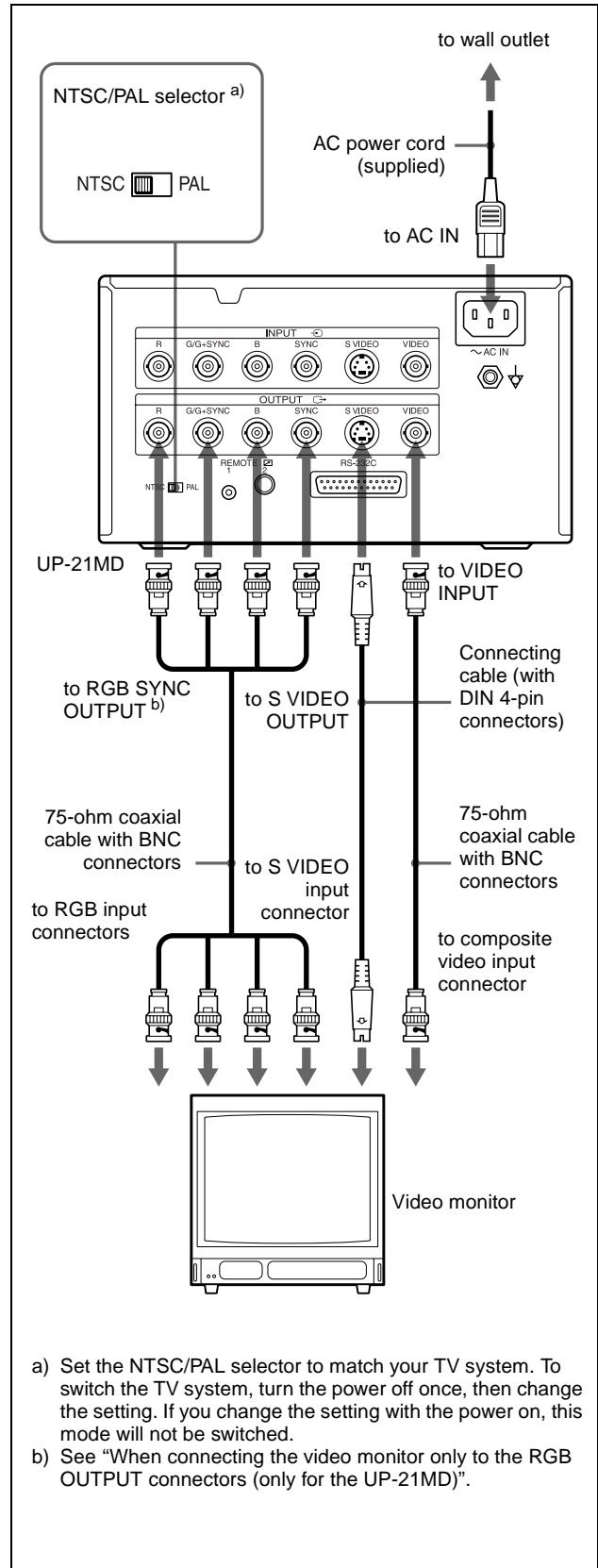

## Making Connections to Enable Remote Control

The printer can be controlled remotely by connecting an RM-5500 Remote Control Unit (not supplied), an RM-91 Remote Control Unit (not supplied), or a personal computer.

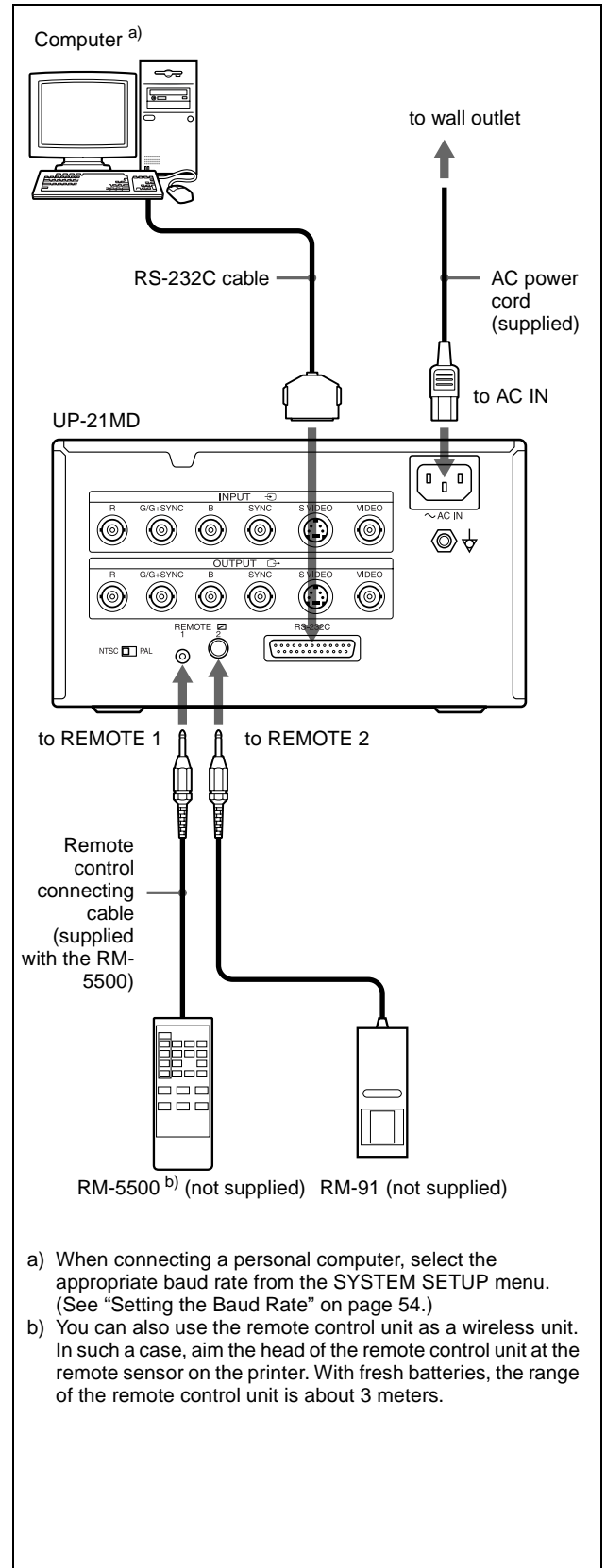

# Before Printing

Before printing, but after mounting the paper tray on the printer and making the necessary connections (see “Connections” on page 10), perform the following as preparation.

- Loading an ink ribbon (See below.)
- Loading paper (See page 14.)
- Selecting the input signal (See page 15.)

## Notes

- Use the ink ribbon and paper contained in the same package as a pair. Before attempting to load an ink ribbon or paper, make sure that the combination of the ink ribbon and paper is compatible.
- When either an ink ribbon or paper has been exhausted, replace both the ink ribbon and paper at the same time.
- Use only ink ribbon and paper designed for use with this printer. Failing to do so is likely to result in malfunctions. (See “Recommended Ink Ribbon and Paper” on page 57.)

## Loading an Ink Ribbon

Load an ink ribbon into the printer’s ink ribbon compartment.

## Notes

- **When you use the printer for the first time, the thermal head is still secured in place. Before attempting to load the ink ribbon, turn on the power while the front panel is closed so that the thermal head is released.**
- When loading or replacing the ink ribbon, turning off the power will cause the image stored in the memory to be lost.
- If a blank sheet of paper is ejected, and the message RIBBON END appears, the ink ribbon has been exhausted. Replace the paper together with the ink ribbon. Do not reuse the ejected blank paper.
- When paper runs out and “0” is displayed as the amount of ink ribbon remaining, load a new ink ribbon and paper at the same time.
- If you load an ink ribbon that is partially used, the correct amount of ink ribbon remaining will not be displayed.
- Once an ink ribbon has been completely used up, replace it. An ink ribbon is not reusable.
- Do not rewind the ink ribbon for reuse.
- Do not touch the ink ribbon or place it in a dusty location. Finger prints or dust on the ink ribbon will result in imperfect printing or malfunction of the head.
- **Use the ink ribbon and paper supplied with the printer for the initial operation check of the**

**printer. The correct amount of ink ribbon remaining is not displayed when the ink ribbon and paper supplied are loaded.**

- 1 Open the front panel by pulling the front panel toward you.

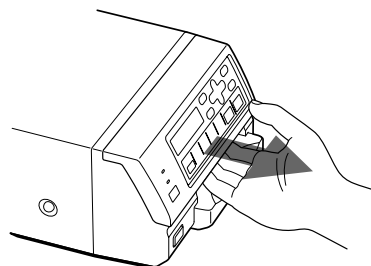

## Note

Be sure not to open the front panel when printing.

- 2 Remove the spent ink ribbon when replacing the ink ribbon.

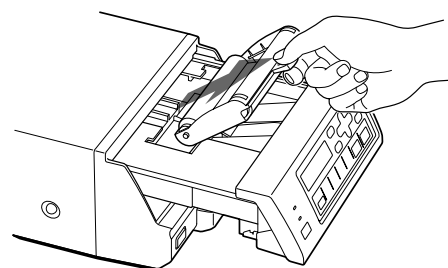

- 3 Remove any slack from the ink ribbon. Wind the spools in the direction of the arrow until the start position marker appears as illustrated.

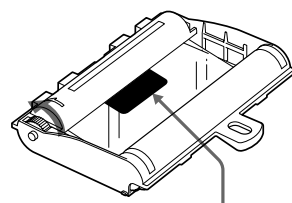

Start position marker

## Note

If the ribbon is left slack, it may be damaged when inserted.

- 4** Load the new ink ribbon into the ink ribbon compartment.

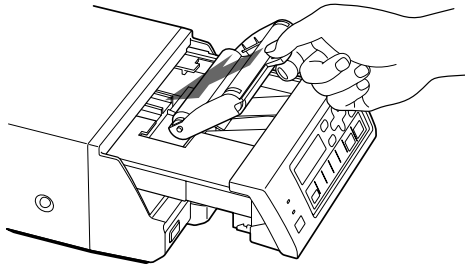

Insert the hole of the handle of the ink ribbon over the protruberance of the printer.

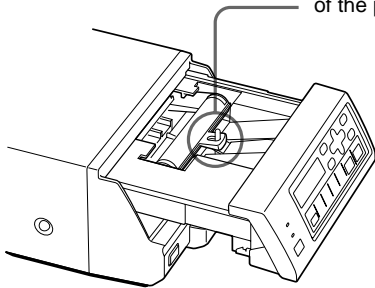

- 5** Close the front panel by pushing the point marked with “PULL OPEN”.

**Note**

Be sure to close the front panel completely. If you do not, a paper jam or a malfunction may occur while you are printing or cleaning the internal thermal head.

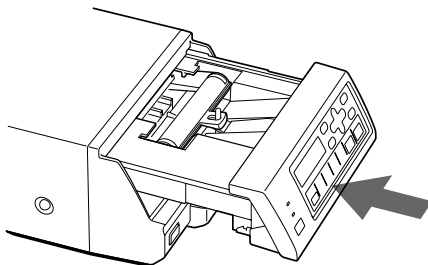

Push the point marked with “PULL OPEN”.

**When storing ink ribbon cartridge:**

- Avoid placing the ink ribbon in a location subject to:
  - high temperatures
  - high humidity
  - excessive dust
  - direct sunlight
- Store a partially used ink ribbon in its original packaging.

**If your ink ribbon should tear**

Repair the tear with transparent tape. There should be no problem with using the remaining portion of the ribbon.

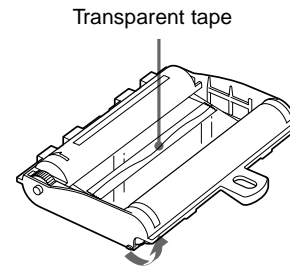

Turn the spools in the direction of the arrow to remove any slack until the transparent tape cannot be seen.

---

**Loading Paper**

To load paper on the paper tray, follow the procedure below. Be careful not to touch the printing surface.

**Note**

Use only paper recommended. Failing to do so is likely to result in malfunctions such as paper jams. (See “Recommended Ink Ribbon and Paper” on page 57.)

- 1** Take out the paper tray. Then, open the cover of the paper tray and place the paper in the paper tray so that the printing surface faces up with the protection sheet on top.

**When the UPC-21L printing pack is used:** Lay the partition down.

**When the UPC-21S printing pack is used:** Raise the partition.

**Notes**

- The paper tray holds up to 50 sheets of paper when the UPC-21L printing pack is used and 80 sheets of paper when the UPC-21S printing pack is used.
- When handling the paper, do not touch the printing surface. Dust or finger prints are likely to cause unsatisfactory printing or malfunction of the head. Grasp the paper by the printing surface protection sheet.
- When loading the paper, load the paper so that it lays flat in the paper tray. If the paper is curled, it will overflow from the paper tray and paper may not be fed properly. Be sure to riffle the paper along with the protection sheets before attempting to place the paper in the paper tray.
- Do not place different types of paper in the tray at the same time.

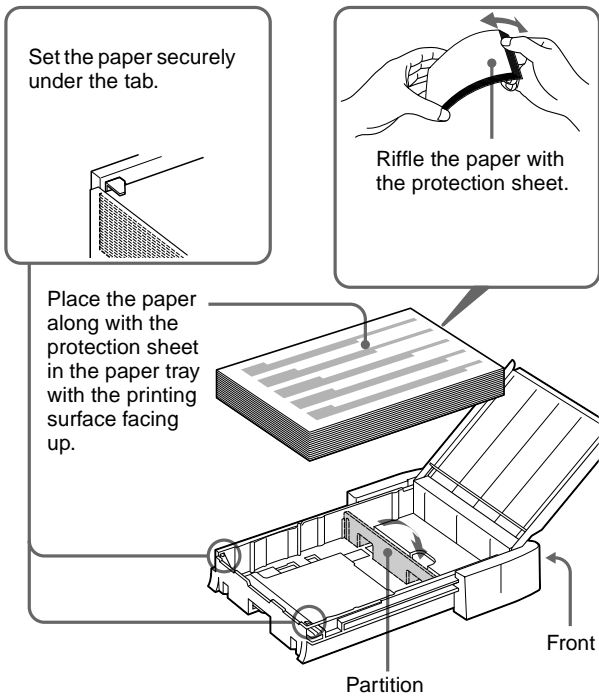

- 2 Remove the protection sheet placed on the top of the paper.
- 3 Close the cover of the paper tray, and then slide the paper tray back into the printer until it clicks into place.

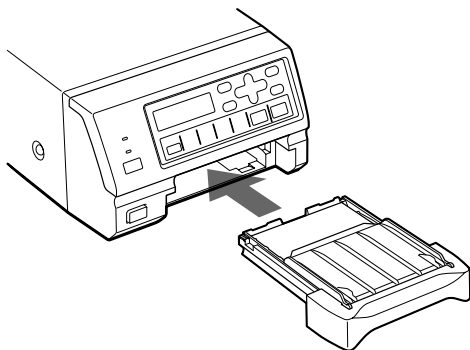

**Note**

When you cannot slide the paper tray back into the printer, check whether or not paper or printouts are left around the paper outlet slot. Remove them if there are.

**When storing the paper**

- Avoid storing the paper in a location subject to:
  - high temperatures
  - high humidity
  - excessive dust
  - direct sunlight
- Use the original package for storing unused paper.

**Selecting the Input Signal**

Before printing, select the appropriate input signal (the input connector to which the signal to be printed is being input) VIDEO, S VIDEO, or RGB.

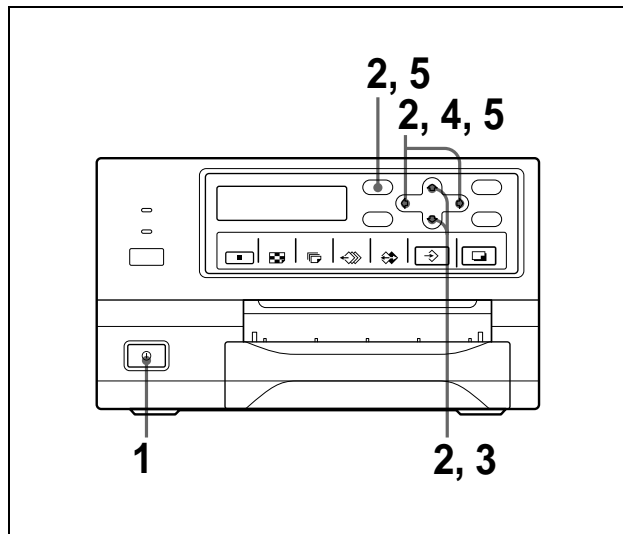

- 1 Turn on the video monitor and the printer.
- 2 Press the MENU button and display the INPUT SETUP menu by pressing the  $\uparrow$ ,  $\downarrow$ ,  $\leftarrow$  or  $\rightarrow$  button.

Switch IN to green by pressing the  $\uparrow$ ,  $\downarrow$ ,  $\leftarrow$  or  $\rightarrow$  button, then the INPUT SETUP menu appears.

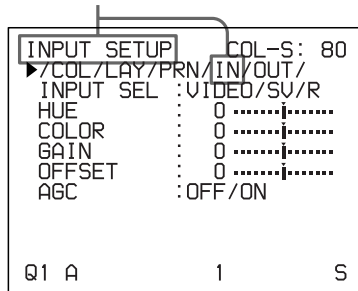

- 3 Select INPUT SEL by pressing the  $\uparrow$  or  $\downarrow$  button.

Position the cursor at INPUT SEL by pressing the  $\uparrow$  or  $\downarrow$  button.

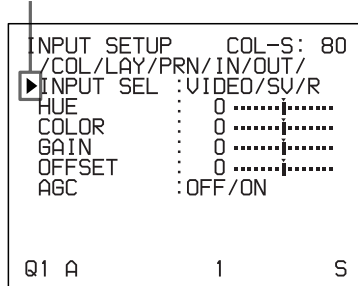

- 4** Select the desired input signal by pressing the  $\leftarrow$  or  $\rightarrow$  button.

Switch the desired input signal to green by pressing the  $\leftarrow$  or  $\rightarrow$  button. The selected input signal turns green and is spelled out.

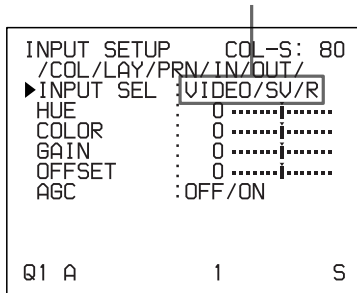

Source signal of the image to be printed	Video monitor and printer window display (the selected input signal is spelled out)
Signal from video equipment connected to the VIDEO INPUT connector	V → VIDEO
Signal from video equipment connected to the S VIDEO INPUT connector	SV → S VIDEO
Signal from video equipment connected to the RGB SYNC INPUT connectors	R → RGB <sup>a)</sup>

- a) The RGB SYNC INPUT connectors are equipped only with the UP-21MD.  
When RGB is selected, \*\*\*\*\* is displayed at the selections of items HUE and COLOR on the INPUT SETUP menu.

- 5** Press the MENU button.  
The regular screen appears.



# Making Full-Size Image Printouts

This section explains how to make a full-size image printout. The operations described here constitute the basic procedure for making a printout.

### Before making a full-size image printout

- All connections should have already been made. (See page 10.)
- Ensure that the appropriate ink ribbon/paper set is being used and that they are correctly loaded. (See pages 13, 14 and 57.)
- Select the input signal to be used to make a printout. (See page 15.)
- Set the printer to capture one full-size image into memory. (See page 26.)
- Select the appropriate memory page. (See page 24.)
- Confirm the printout color quality (using, for example, the LOAD COLOR number). (See page 45.)

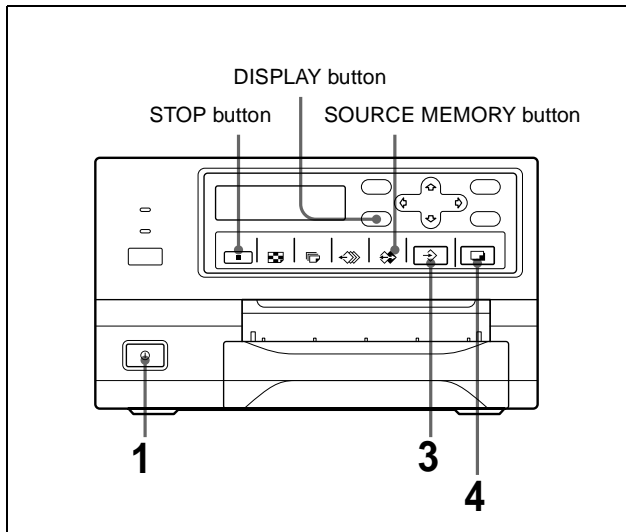

**1** Turn on the video monitor and the printer.

**2** Start the video source to display the source image on the video monitor. This operation is done using the controls of the video equipment acting as the source.

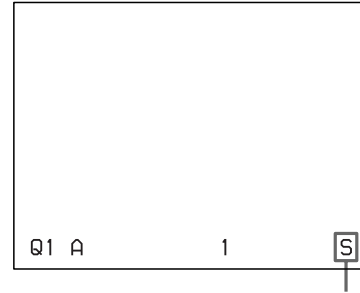

Shows that an image from the source equipment is currently displayed on the screen.

**3** Press the CAPTURE button at the instant the image you want to print appears on the screen. The image is captured into memory. The memory image is displayed on the screen. Which image appears after this, the source image or the memory image, depends on the setting made with the FUNCTION SETUP facility of the printer. (See page 27.)

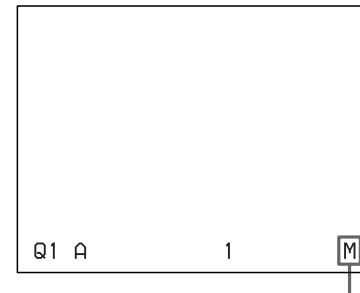

Shows that an image captured in memory is displayed on the monitor.

### If the captured image is blurred

A quickly moving image may be blurred when captured. Should this occur, change the memory mode setting to FIELD, then print it again. Although the blur should be eliminated, the ultimate print quality will be slightly degraded. Select the FIELD mode on the LAYOUT SETUP menu. (See "Selecting the memory mode" on page 24.)

## Note

Usually, it is recommended that you make printouts in FRAME mode.

You can confirm the memory mode setting on the bottom part of the video monitor screen.



When FRAME mode is selected:



When FIELD mode is selected:

### To change the image captured in memory

- ① To display the source image when the memory image is displayed on the screen, press the SOURCE/MEMORY button.
- ② Press the CAPTURE button at the instant the image you want to print appears. The previous image is replaced with the new one.

- 4 Press the PRINT button. The printout pops out on the paper tray.

The printing time depends on the type of paper and printer settings.

On the video monitor, Q display blinks in the color which is being printed.

The color changes as follows during printing:  
Start → yellow → magenta → cyan → finish

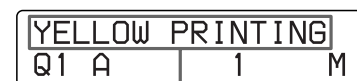
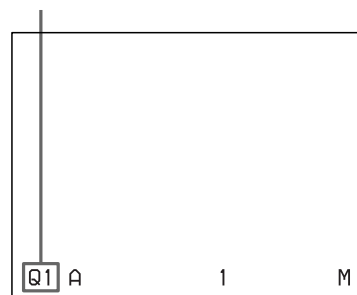

On the printer window display (only for the UP-21MD), the color indication changes as the color printing precedes:

Start → YELLOW → MAGENTA → CYAN → finish

## Notes

- Do not turn off the power during printing. If you do so, paper may not be ejected and may jam in the printer.
- Do not leave more than 10 sheets of printouts on the paper tray. Doing so may cause a paper jam. Even if fewer than 10 sheets of printouts have been accumulated on the paper tray, the printer may stop printing for various reasons and the message “REMOVE PRINTS” appears. In such a case, remove printouts accumulated on the paper tray. The printer will start to print automatically.
- You can not change the printer application mode or settings using the WINDOW SETUP menu during printing.

### To stop printing

- When you make one printout, you can not stop printing midway. Wait until a printout pops out on the paper tray.
- When you make multiple copies, press the STOP button. (For detailed information on setting the print quantity, see “Making Multiple Copies of Identical Printouts” on page 20.) The printer stops printing when the page currently printing is completed. Also, any printing job queued are cancelled.

### If the printer does not print

The printer will fail to print in the following cases:

- While an error message is displayed on the video monitor screen and printer window display.

- Proceed as described in “Error/Warning Messages” on page 61.
- When an image has not been stored in memory.
  - Image data stored in memory is lost if you turn off the power. Capture the image into memory again, then press the PRINT button. If no image is stored in memory, the printer will not print even if you press the PRINT button.

**To make a printout at high speed**

You can select the speed using the PRN SPEED item on the PRINTER SETUP menu.

When you want to	PRN SPEED
Make a printout at normal speed.	NORMAL
Make a printout at high speed.	HIGH

For detailed information on how to operate the menu, see “Basic Menu Operations” on page 40.

**When you want to see an image that is hidden below a screen message**

You can erase screen messages (such as Q1, A and so on) from the video monitor screen by pressing the DISPLAY button. The screen message disappears. To display a screen message, press the DISPLAY button again. (See “Erasing the Screen Display on the Video Monitor” on page 36.) You can also erase the information about ink ribbon and paper. (See “Displaying the Type and Remaining Amount of the Ink Ribbon” on page 54.)

**If a black line appears on the printout**

Sometimes, a black line appears on the printout, although it does not appear on the video monitor. This black line can be eliminated from the printout. (See “When a Black Frame or Lines Show up on the Printouts” on page 47.)

**If the color quality of the printouts is not satisfactory**

You can obtain satisfactory color quality of the printouts by compensating for the input signal and/or adjusting the color quality of the printouts. (See “Compensating for the Input Signals” on page 43 and “Adjusting the Printout Color” on page 45.)

When you load a new ink ribbon and paper, the color balance may change due to differences caused by the new pair of ink ribbon and paper in the new printing pack. It is recommended that you adjust the color balance each time you load a new ink ribbon and paper. (“Adjusting the Color Balance” on page 48.)

**When storing your printouts:**

- Avoid storing the printout in a location subject to high temperatures, high humidity, excessive dust or direct sunlight.

- Do not stick tape on a printout. Also, avoid leaving a plastic eraser on a printout or placing a printout in contact with materials which contain plasticizer (under a desk mat, for example).
- Do not allow alcohol or other volatile organic solvents to come into contact with the printouts.

**Making Printouts with the Desired User Set Number**

You can register all the printer settings as a user settings. The printer allows you to register three sets of settings as User Set 1, 2 and 3. (See “Registering a User Set” on page 54.) By selecting a desired user set number, the printer functions according to the corresponding settings. You can change a part of the selected user settings and make printouts.

**Note**

If you change the currently selected user set to another one, the image stored in memory pages will be cleared. Be sure to change the LOAD USER number before capturing the image.

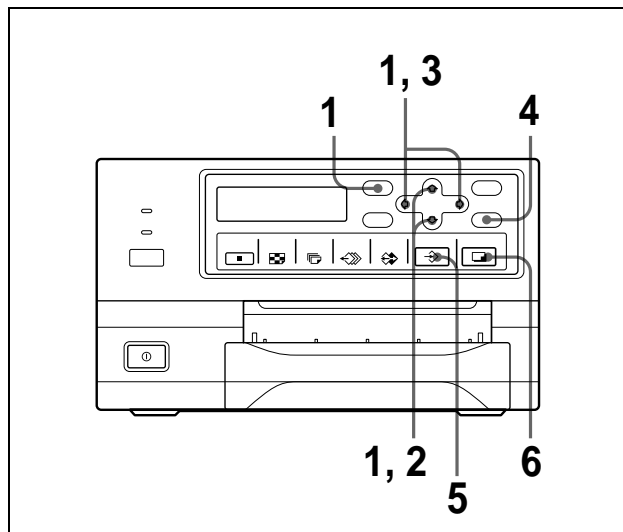

- 1 Press the MENU button, and display the PRINTER SETUP menu by pressing the  $\uparrow$ ,  $\downarrow$ ,  $\leftarrow$  or  $\rightarrow$  button.

Switch PRN to green by pressing the  $\uparrow$ ,  $\downarrow$ ,  $\leftarrow$  or  $\rightarrow$  button, then the PRINTER SETUP menu appears.

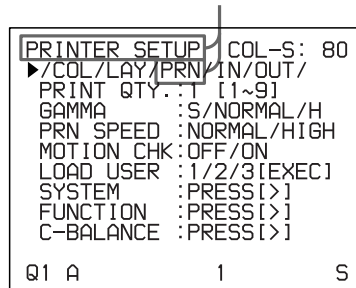

**2** Select LOAD USER by pressing the  $\uparrow$  or  $\downarrow$  button.

Position the cursor at LOAD USER by pressing the  $\uparrow$  or  $\downarrow$  button. The currently selected load user number is lit in green.

```

PRINTER SETUP COL-S: 80
/COL/LAY/PRN/IN/OUT/
PRINT QTY.:1 [1~9]
GAMMA :S/NORMAL/H
PRN SPEED :NORMAL/HIGH
MOTION CHK:OFF/ON
▶LOAD USER :1/2/3[EXEC]
SYSTEM :PRESS[>]
FUNCTION :PRESS[>]
C-BALANCE :PRESS[>]

Q1 A 1 S
    
```

**3** Select the desired user number by pressing the  $\leftarrow$  or  $\rightarrow$  button.

Switch the desired user number to green by pressing the  $\leftarrow$  or  $\rightarrow$  button.

```

PRINTER SETUP COL-S: 80
/COL/LAY/PRN/IN/OUT/
PRINT QTY.:1 [1~9]
GAMMA :S/NORMAL/H
PRN SPEED :NORMAL/HIGH
MOTION CHK:OFF/ON
▶LOAD USER :1/2/3[EXEC]
SYSTEM :PRESS[>]
FUNCTION :PRESS[>]
C-BALANCE :PRESS[>]

Q1 A 1 S
    
```

**4** Press the EXEC button.  
The user set selected in step 3 is executed.  
While the selected user set is being executed, the following message appears.

When the user name is registered, the user name appears.

```

USER PRESET-3 LOADING
- USER SETUP 3 -

PLEASE WAIT
    
```

**5** Press the CAPTURE button at the instant the image you want to print appears on the screen.  
The image is captured into memory according to the user set selected in step 3.

**6** Press the PRINT button.  
The printer makes printouts according to the user set selected in step 3.

## Making Multiple Copies of Identical Printouts

You can make up to 9 copies of identical printouts.

### Setting the printout quantity

The following two methods are available to set the number of printouts.

- Using the PRINT QTY button  
However, you cannot use this button to decrease the number of printouts.
- Using the menu  
You can change the designated number of copies before printing or any time during printing.

### To set the printout quantity by using the PRINT QTY button

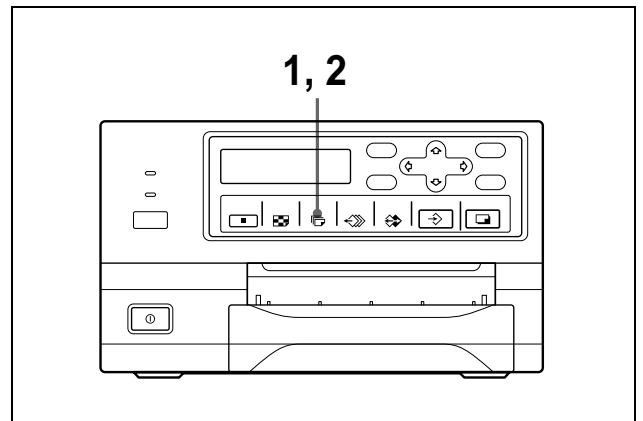

- 1** Press the PRINT QTY button.  
The following screen appears.  
If you do not perform any operation after you press the PRINT QTY button, the currently set number of copies appears for a few seconds, after which it disappears.

```

▶PRINT QTY. 1 [1~9]
    
```

Currently selected number of copies

- 2 Press the PRINT QTY button until the desired number appears, while the screen which appears in step 1 is displayed.

Repeatedly pressing the PRINT QTY button increases the number up to a maximum of 9. Or repeatedly pressing the ⇨ button also increases the number up to a maximum of 9.

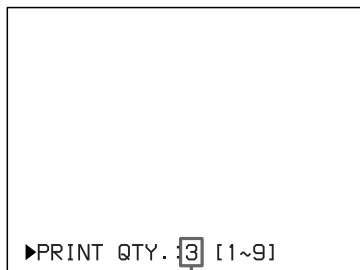

Press the PRINT QTY button or ⇨ button until the desired number appears.

### To decrease the number of copies

While the screen which appears in step 1 is displayed, press the ⇨ button. Each time you press the ⇨ button, the number decreases and stops at 1.

### Setting the printout quantity using the menu

- 1 Display the PRINTER SETUP menu according to the operations of step 1 described in “Making Printouts with the Desired User Set Number” on page 19.
- 2 Select PRINT QTY by pressing the ⇨ or ⇩ button.

Position the cursor at PRINT QTY by pressing the ⇨ or ⇩ button.

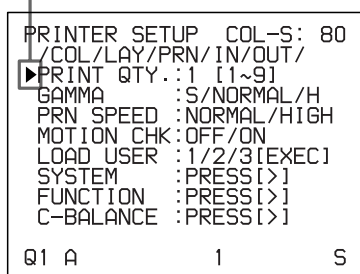

- 3 Select the desired number of copies by pressing the ⇨ or ⇩ button.

When you want to	Button
Increase the quantity.	⇨
Decrease the quantity.	⇩

Display the desired number of copies by pressing the ⇨ or ⇩ button.

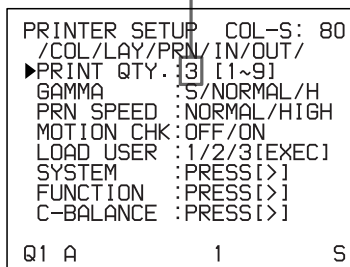

- 4 Press the MENU button. The regular screen appears.

### Note

Do not leave more than 10 sheets of printouts on the paper tray. Doing so may cause a paper jam. Even if fewer than 10 sheets of printouts have been accumulated on the paper tray, the printer may stop printing for various reasons and the message “REMOVE PRINTS” appears. In such a case, remove printouts accumulated on the paper tray. The printer will start to print remaining copies automatically.

### If the paper runs out during printing

The printer stops the printing operation. Load the paper into the paper tray and press the PRINT button.

However, the printout quantity is reset to the original quantity requested before printing was stopped. For example, if the printout quantity is set to 5, and the paper runs out when three copies are printed, the printout quantity is reset to 5. If you want to print only the remaining copies, set the printout quantity to 2 after loading the paper. (See “Loading Paper” on page 14.)

## Capturing Another Image While Printing

While the printer is printing, you can queue printing jobs by capturing another image into another memory page to be printed once the printer becomes free. The number of usable memory pages depend on the type of printouts and settings. (See page “Memory page” on page 24.)

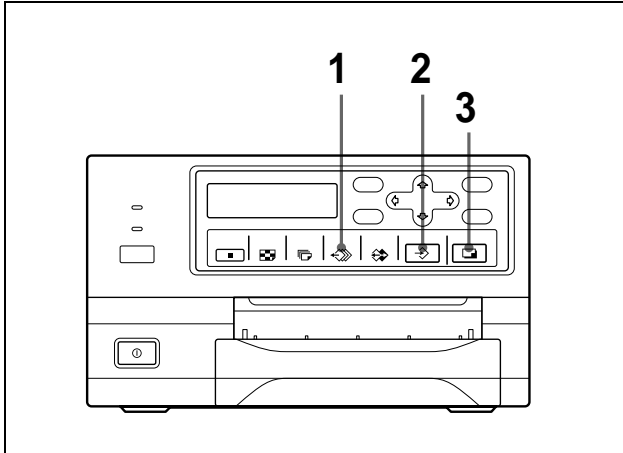

- 1 Select the desired memory page by pressing the MEMORY PAGE button. Pressing the MEMORY PAGE button switches the memory page.

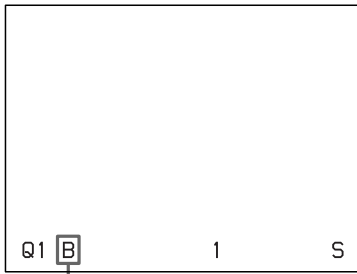

The available memory pages appear in white.

- 2 Press the CAPTURE button at the instant the image you want to print appears on the screen.

- 3 Press the PRINT button. The image captured in step 2 is queued. The image is printed as soon as all previous printing jobs have been completed.

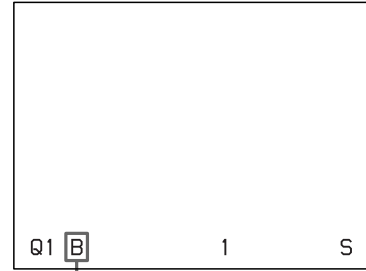

Memory page whose image has been queued for printing (blinks white on the video monitor)  
The memory page display returns to white on the video monitor once printing has been completed.

### Note

Another image cannot be stored in a memory page in which an image has already been queued for printing (memory page indication blinks in white). In such a case, the “PRINTING MEMORY” message appears on the video monitor. For the UP-21MD, the “PLEASE WAIT NOW PRINTING” message also appears in the printer window display.

- 4 To queue another memory page, repeat steps 1, 2 and 3.

# Making Variations of Printouts

You can capture various kinds of images in memory and make variations of printouts using the images captured in memory.

Printout of a full-size image



Printout of two reduced images

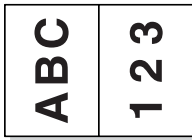

Printout of four reduced images

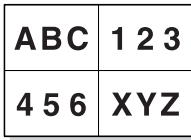

You can also make printouts of multiple reduced images with white borders. (See “Making a printout with white borders” on page 30.)

## Selecting the Memory Mode

### Frame mode/field mode

To make printouts, it is first necessary to capture the image in memory.

When capturing an image, there are two ways to use the memory, one is called frame mode and the other is called field mode.

**Frame mode:** An image is captured in a memory area. Printouts with high resolution can be obtained.

Video monitor



The image displayed on the video monitor is captured in memory page A.

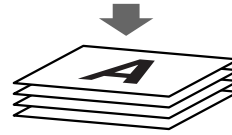

Printout



A still subject can be printed with high resolution.

**Field mode:** A memory area is divided into two, and images can be captured in each. In this way a quickly moving subject can be printed with less blurring.

Video monitor

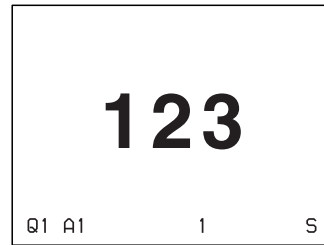

The image displayed on the video monitor is captured in memory page A1.

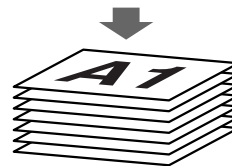

Printout

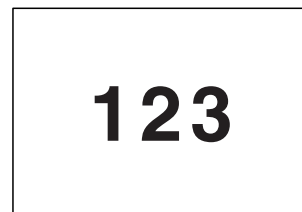

A quickly moving subject can be printed with less blurring.

## Selecting the memory mode

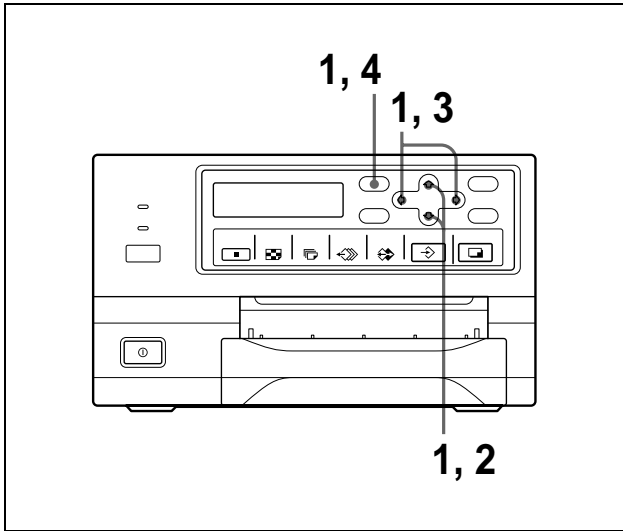

- 1 Press the MENU button and display the LAYOUT SETUP menu by pressing the  $\uparrow$ ,  $\downarrow$ ,  $\leftarrow$  or  $\rightarrow$  button.

Switch LAY to green by pressing the  $\uparrow$ ,  $\downarrow$ ,  $\leftarrow$  or  $\rightarrow$  button, then the LAYOUT SETUP menu appears.

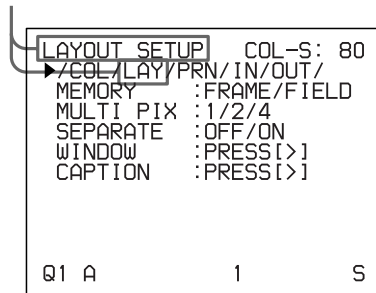

- 2 Select MEMORY by pressing the  $\uparrow$  or  $\downarrow$  button.

Position the cursor at MEMORY by pressing the  $\uparrow$  or  $\downarrow$  button.

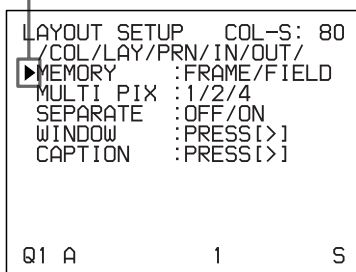

- 3 Select the desired memory mode by pressing the  $\leftarrow$  or  $\rightarrow$  button.

Switch the desired memory mode to green by pressing the  $\leftarrow$  or  $\rightarrow$  button.

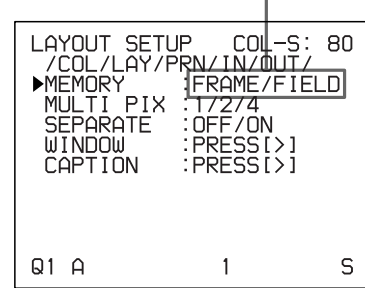

Mode	Contents
FRAME	We recommend that, whenever possible, you print in this mode.
FIELD	Select this mode to reduce blurring when you print a quickly moving image.

- 4 Press the MENU button. The regular screen appears.

## Selecting a Memory Page

### Memory page

A memory area in which an image is captured is called a memory page in this manual.

The number of usable memory pages depends on the type of the reduced images selected and on the memory mode.

Usable memory page	Type of reduced images to be captured in memory
FRAME	FIELD
A, B, C, D	A1, A2, B1, B2, C1, C2, D1, D2
A, B	A1, A2, B1, B2
A	A1, A2



## Selecting a memory page

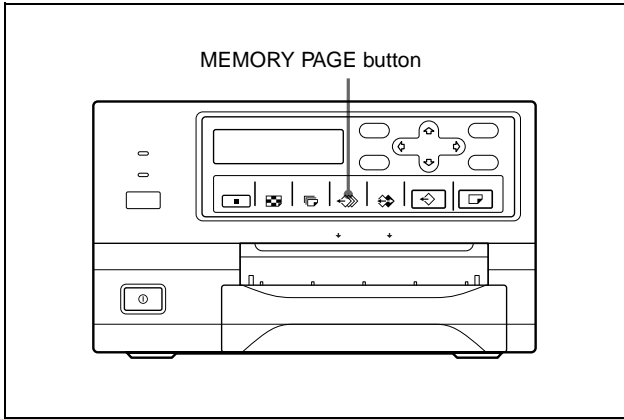

Press the MEMORY PAGE button repeatedly until the desired memory page appears.

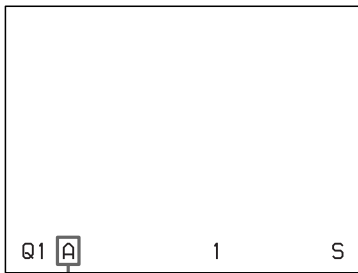

Currently selected memory page

# Making a Printout of Multiple Different Reduced Images

You can capture multiple images in a memory page and make a printout with those reduced images. This section explains how to make a printout with multiple reduced images.

A printout having multiple reduced images is made using the procedure below.

- Determining the number of reduced images (See below.)
- Selecting the memory page (See page 25.)

## Selecting the number of reduced images to be captured in memory

The following two methods are available to select the memory mode:

- Using the MULTI PICTURE button
- Using the menu

## To select the desired type of reduced images to be captured in memory using the MULTI PICTURE button

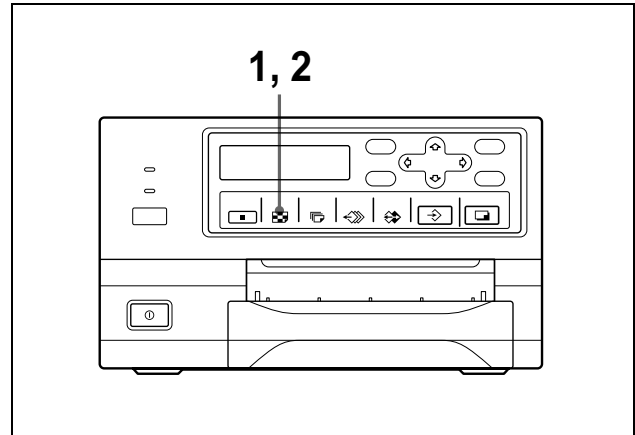

- 1 Press the MULTI PICTURE button.  
The following screen appears.

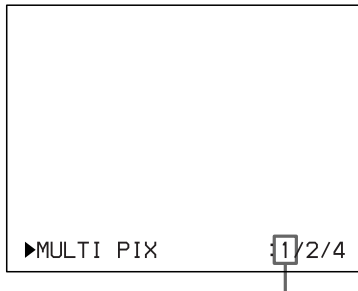

The currently selected type of reduced images to be captured in memory is lit in green.

If you do not perform any operation after you press the MULTI PICTURE button, the current setting appears for a few seconds, after which it disappears.

- 2 Select the type of reduced images to be captured in memory by pressing the MULTI PICTURE button, while the screen which appears in step 1 is displayed.  
Press the MULTI PICTURE button repeatedly until the color of the type of reduced images to be captured in memory turns green on the video monitor, or until the type of reduced images to be captured in the memory is displayed on the printer window display (only for the UP-21MD).  
Each time you press the MULTI PICTURE button, the type of reduced-image printout changes in the following sequence: 1, 2, 4, 1....

Type	Number of reduced images
1	1 (Full-size image)
2	2 (Two reduced images)
4	4 (Four reduced images)

The screen is reset to the regular screen after a few seconds.

### To select the type of reduced images to be captured in the memory using the menu

- 1 Display the LAYOUT SETUP menu according to the operations of step 1 described in “Selecting the memory mode” on page 24.

- 2 Select MULTI PIX by pressing the  $\uparrow$  or  $\downarrow$  button.

Position the cursor at MULTI PIX by pressing the  $\uparrow$  or  $\downarrow$  button.

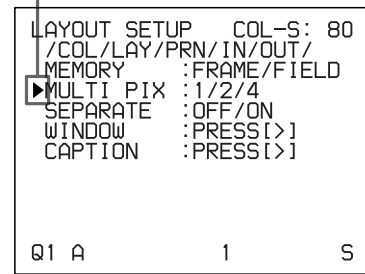

- 3 Select the type of reduced images to be captured in memory by pressing the  $\leftarrow$  or  $\rightarrow$  button.

Switch the type of reduced images to be captured in memory to green by pressing the  $\leftarrow$  or  $\rightarrow$  button.

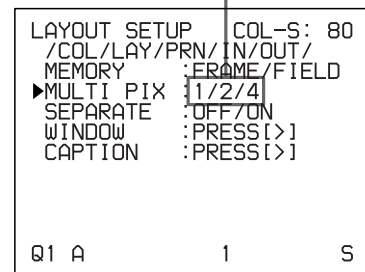

- 4 Press the MENU button.  
The regular screen appears.

## Deciding which image is displayed on the video monitor screen after capturing an image

You can switch image displayed on the video monitor screen after capturing an image, a memory image or a source image.

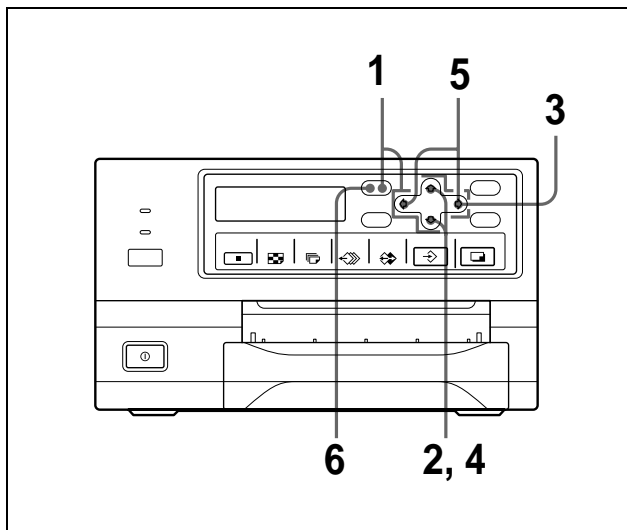

**1** Display the PRINTER SETUP menu according to the operations of step 1 described in “Making Printouts with the Desired User Set Number” on page 19.

**2** Select FUNCTION by pressing the  $\uparrow$  or  $\downarrow$  button.

Position the cursor at FUNCTION by pressing the  $\uparrow$  or  $\downarrow$  button.

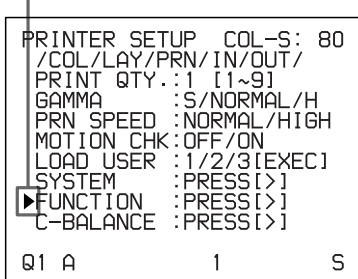

**3** Press the  $\rightarrow$  button.  
The FUNCTION SETUP menu appears.

**4** Select AUTO LIVE by pressing the  $\uparrow$  or  $\downarrow$  button.

Position the cursor at AUTO LIVE by pressing the  $\uparrow$  or  $\downarrow$  button.

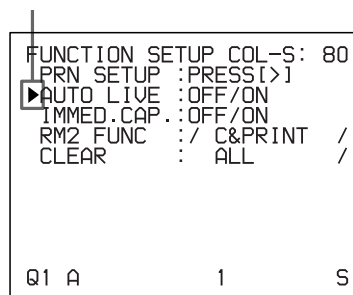

**5** Select which image appears on the video monitor after the image is captured, by pressing the  $\leftarrow$  or  $\rightarrow$  button.

When	Setting
The image captured in memory appears just after the printer captures the image, and the memory image remains on the video monitor screen.	OFF
The image captured in memory appears just after the printer captures the image, then after a few seconds, the source memory appears, whenever you press the CAPTURE button.	ON

**6** Press the MENU button.  
The regular screen appears.

### To return to the PRINTER SETUP menu

In step 6, position the cursor at PRN SETUP and press the  $\rightarrow$  button.

The PRINTER SETUP menu appears again.

## Making a printout with multiple reduced images

This subsection explains how to make printouts of multiple reduced images taking, as an example, the making of a printout of four reduced images.

### Before making the printout of four reduced images

- Confirm the printout color quality (using, for example, the LOAD COLOR number). (See page 45.)
- Select the type of four-reduced image to be captured in memory. (See page 25.)
- Select the appropriate memory page. (See page 25.)
- Select which image will appear after the image has been captured into memory, the memory image or the source image. (See page 27.)
- Select whether the white borders are to be added. (See page 30.)

You can select whether white borders are added before or after capturing the four reduced images in the memory.

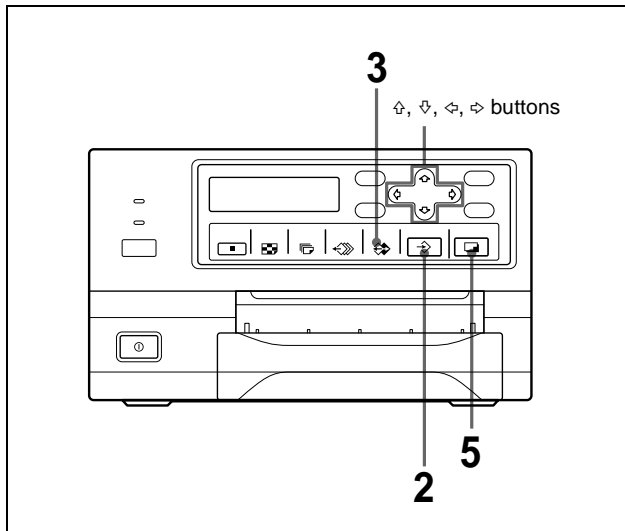

- 1 Start the video source.  
This operation is done using the controls of the video equipment acting as the source.

The memory page in which the four reduced images are to be captured. Blinks in green to indicate that an image will be captured here.

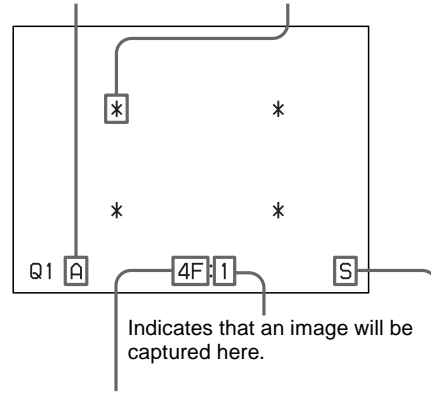

- Type of multiple reduced images to be captured
- F: Indicates that white borders are to be attached around the images. When white borders are attached, 4F is displayed. When white borders are not attached, 4 is displayed.
- Indicates that the images from a piece of video equipment are displayed on the screen.

- 2 Press the CAPTURE button at the instant the image you want to print appears on the screen. The image is captured in the location indicated by the green blinking star on the video monitor screen or the position number displayed on the printer window display in step 1. The green blinking star (referred to as the cursor) on the video monitor moves to the next position and the number on the printer window display advances by 1.

The blinking cursor moves to the next position.

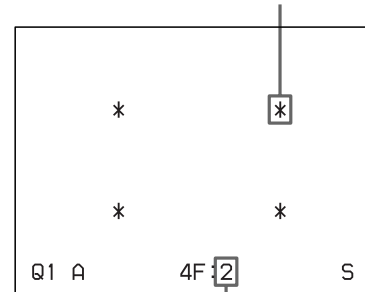

At this time, the image captured in memory is displayed on the video monitor screen. However, the image to be displayed after a few seconds depends on the setting of AUTO LIVE in the FUNCTION SETUP menu. (See page 27.) When the source image is displayed at the position where the next image is to be captured, go to step 4.

- 3 Press the SOURCE/MEMORY button.  
The source image appears on the video monitor screen.
- 4 Repeat steps 2 and 3 until you have captured four images when the memory image remains on the video monitor screen.  
Repeat step 2 until you have captured four images when the source image appears on the video monitor screen at the next position where the image is to be captured.

### To replace a captured image

Example: When you want to change the image captured in the third position.

- ① Select the third position where the image which you want to replace is located by pressing the  $\uparrow$ ,  $\downarrow$ ,  $\leftarrow$  or  $\rightarrow$  button.  
Pressing the  $\uparrow$ ,  $\downarrow$ ,  $\leftarrow$  or  $\rightarrow$  button moves the cursor one position by one position vertically or horizontally.

Press the  $\uparrow$ ,  $\downarrow$ ,  $\leftarrow$  or  $\rightarrow$  button until the third cursor blinks green.

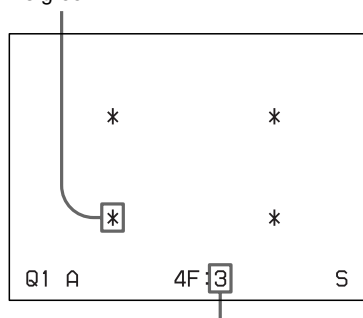

Press the  $\leftarrow$ ,  $\downarrow$ ,  $\rightarrow$  or  $\rightarrow$  button until a 3 appears.

- ② Display the source image on the video monitor.  
For detailed information on how to display the source image, see step 3.
- ③ Press the CAPTURE button at the instant the image you want to print appears.  
The previously captured image is replaced with the newly captured image.

### To keep a previously captured image

Skip images that you want to keep by pressing the  $\uparrow$ ,  $\downarrow$ ,  $\leftarrow$  or  $\rightarrow$  button.

- 5 Press the PRINT button.  
The four reduced images are printed on one sheet of paper.  
Whether white borders are attached depends on the setting of SEPARATE in the LAYOUT SETUP menu. (See page 30.)

### If the printout is blurred

When you make a printout of a full image, or two or four reduced images captured in memory in FRAME mode, the images on a printout may be blurred. Should this occur, change the memory mode setting to FIELD on LAYOUT SETUP menu (“Selecting the memory mode” on page 24), then print it again. Although the blur should be eliminated, the ultimate print quality will be slightly degraded.

#### Note

Usually, it is recommended that you make printouts in FRAME mode. Check the setting on the LAYOUT SETUP menu.

### To confirm whether the captured images are blurred on the video monitor

You can check whether the images captured in memory are blurred on the video monitor.

**When you select a full image:** You can check whether the captured image is blurred by displaying the memory image on the video monitor.

**When you select two or four reduced images to be captured:** Set the MOTION CHECK function to ON on the PRINTER SETUP menu. You can check whether the reduced images captured in memory are blurred on the video monitor. In this case, the quality of the image on the video monitor will be slightly degraded.

#### Note

The MOTION CHECK function is available only for the images displayed on the video monitor. To eliminate blur from the printout, change the memory mode setting to FIELD. (See “If the printout is blurred.”)

- 1 Display the PRINTER SETUP menu according to the operations of step 1 described in “Making Printouts with the Desired User Set Number” on page 19.
- 2 Select MOTION CHK by pressing the  $\uparrow$  or  $\downarrow$  button.

Position the cursor at MOTION CHK by pressing the  $\uparrow$  or  $\downarrow$  button.

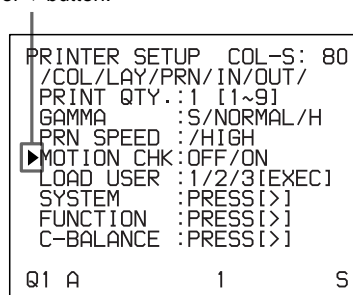

- 3** Select the desired setting by pressing the  $\leftarrow$  or  $\rightarrow$  button.

Switch the desired setting to green by pressing the  $\leftarrow$  or  $\rightarrow$  button.

```

PRINTER SETUP COL-S: 80
/ COL/LAY/PRN/IN/OUT/
PRINT QTY.:1 [1~9]
GAMMA :S/NORMAL/H
PRN SPEED :NORMAL/HIGH
▶MOTION CHK:OFF/ON
LOAD USER :T/2/3TE[EXEC]
SYSTEM :PRESS[>]
FUNCTION :PRESS[>]
C-BALANCE :PRESS[>]

Q1 A 1 S
  
```

When you want to	Setting
See letters or fine images of two or four reduced images on the video monitor.	OFF
Confirm whether the two or four reduced images captured in the memory are blurred.	ON

- 4** Press the MENU button.  
The regular screen appears.

### Making a printout with white borders

The unit allows you to decide whether or not the images are printed with white borders.

**Note**

This setting is also effective for the images which have been captured.

- 1 Display the LAYOUT SETUP menu according to the operations of step 1 described in “Selecting the memory mode” on page 24.
- 2 Select SEPARATE by pressing the  $\uparrow$  or  $\downarrow$  button.

Position the cursor at SEPARATE by pressing the  $\uparrow$  or  $\downarrow$  button.

```

LAYOUT SETUP COL-S: 80
/ COL/LAY/PRN/IN/OUT/
MEMORY :FRAME/FIELD
MULTI PIX :1/2/4
▶SEPARATE :OFF/ON
WINDOW :PRESS[>]
CAPTION :PRESS[>]

Q1 A 1 S
  
```

- 3** Select whether the images are printed with or without white borders by pressing the  $\leftarrow$  or  $\rightarrow$  button.

Switch the desired setting to green by pressing the  $\leftarrow$  or  $\rightarrow$  button.

```

LAYOUT SETUP COL-S: 80
/ COL/LAY/PRN/IN/OUT/
MEMORY :FRAME/FIELD
MULTI PIX :1/2/4
▶SEPARATE :OFF/ON
WINDOW :PRESST>]
CAPTION :PRESS[>]

Q1 A 1 S
  
```

When you want to	Setting
Print the images without white borders.	OFF
Print the images with white borders.	ON <sup>a)</sup>

a) F is attached to the type of printout at the printer operation mode display section on the video monitor.  
Example: 4F

- 4** Press the MENU button.  
The regular screen appears.

# Making Printouts With a Caption

A caption, such as data or comments, can be added to a printout below the image.  
You can input up to 58 characters on one lines.

## About the CAPTION menu

A caption is entered from the CAPTION menu.  
A brief explanation of each item of the CAPTION menu is given below.

Symbols and words can be used to enter a caption

Display in the CAPTION menu	Function
INS	Inserts one character without erasing the highlighted character.
DEL	Deletes a highlighted character and characters shift back by one.
SP	Puts one space at the position of the highlighted character by erasing that character. One space is left.
OFF	Selects printing without a caption.
ON	Selects printing with a caption.
EXIT	Returns from the CAPTION menu to the LAYOUT SETUP menu.
SHIFT	Selects either capital letters or small letters.

Symbols and words can be used to enter a caption.

**Character entry area**  
The character or symbol where the cursor is located is highlighted in green and this highlighted character is to be entered.

**Character display area**  
The cursor lit in green indicates the position where a character can be entered. The entered characters are displayed here.

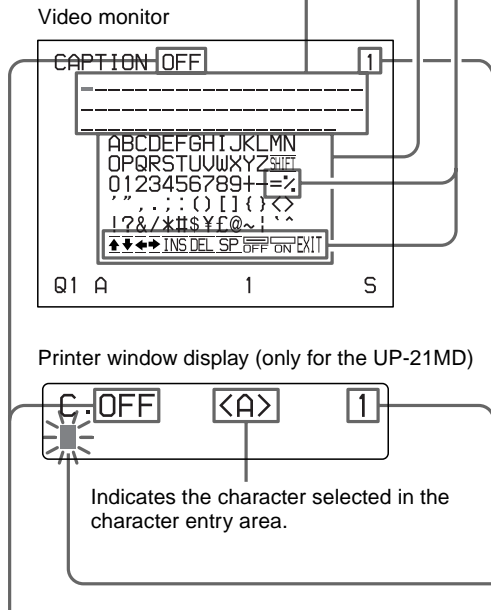

Indicates the character selected in the character entry area.

ON: displayed when printing with a caption.  
OFF: displayed when printing without a caption. (OFF is displayed as the factory-setting.)

Indicates the position the character is to be input in the character display area.

## Entering a Caption

Enter a caption as follows.  
The setting remains effective until you enter a new setting – even if you turn the power off.

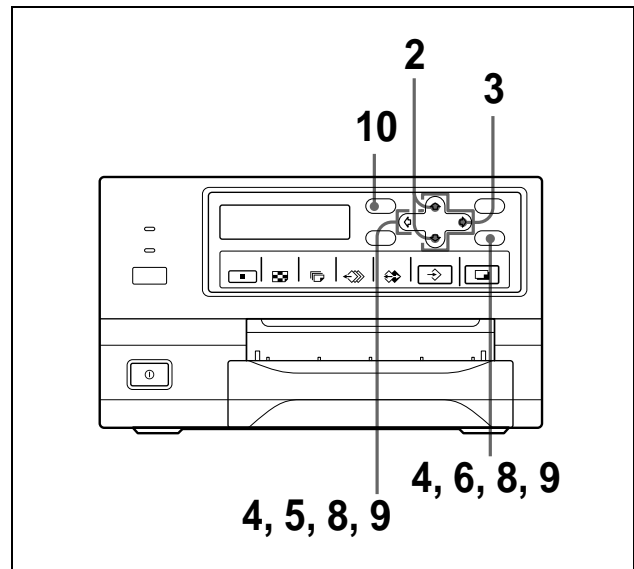

- 1 Display the LAYOUT SETUP menu according to the operations of step 1 described in “Selecting the memory mode” on page 24.

**2** Select CAPTION by pressing the  $\uparrow$  or  $\downarrow$  button.

Position the cursor at CAPTION by pressing the  $\uparrow$  or  $\downarrow$  button.

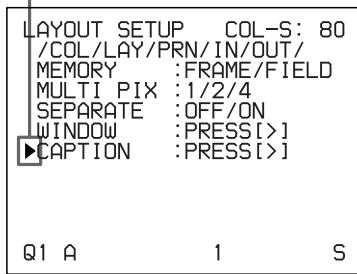

**3** Press the  $\rightarrow$  button.  
The CAPTION menu appears.

**4** Position the cursor (the line lit in green) at the point where you want to enter the character in the character display area.

**To move the cursor**

- ① Select the arrow corresponding to the direction in which you want to move the green cursor in the character display area, by pressing the  $\uparrow$ ,  $\downarrow$ ,  $\leftarrow$  or  $\rightarrow$  button.
- ② Press the EXEC button.  
Each time you press the EXEC button, the cursor moves one position in the designated direction.

**Example: Move the cursor to the left by two.**

- ① Highlight the  $\leftarrow$  button in green. The cursor is currently positioned here (lit in green).

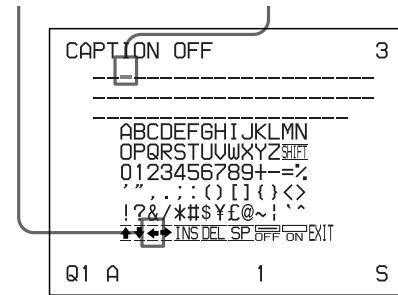

- ② Press the EXEC button twice.

The blinking cursor moves to this position.

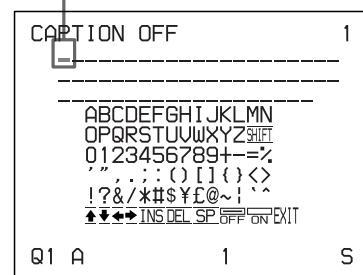

**5** Select the character you want to enter by pressing the  $\uparrow$ ,  $\downarrow$ ,  $\leftarrow$  or  $\rightarrow$  button.

**Example: Enter S.**

Highlight S in green by pressing the  $\uparrow$ ,  $\downarrow$ ,  $\leftarrow$  or  $\rightarrow$  button. S blinks in green.

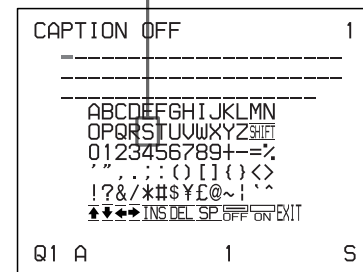

**When you enter characters on the printer window display (only for the UP-21MD):**  
It is recommended that you display the characters to be entered on the printer window display by pressing either  $\leftarrow$  or  $\rightarrow$  button.

**When the cursor is positioned at the right end:**  
The cursor moves to the left end on the next line when you press the  $\rightarrow$  button.



For example, when the cursor is positioned at N, pressing the ⇨ button results in the cursor moving to O at the left end on the next line.

### When the cursor is positioned at EXIT:

Only the ⇨ and ⇩ buttons are effective. If you press the ⇨ button, the cursor moves to the top on the first line, that is A. If you press the ⇩ or ⇨ button, the error tone sounds.

### To select either capital letters or small letters

You can change the characters in the character entry area from capital letters to small letters or vice versa.

- 1 Highlight SHIFT in green by pressing the ⇧, ⇩, ⇨ or ⇩ button on the video monitor.

When characters are displayed in capital letters in the character entry area, SHIFT is displayed in the printer window display (only for the UP-21MD). When displayed in small letters, shift is displayed.

- 2 Press the EXEC button.

Capital letters are changed to small letters, or small letters are changed to capital letters in the character entry area.

#### Note

Characters already entered (displayed in the character display area) are not changed even if letters are changed in the character entry area.

- 6 Press the EXEC button.

The character selected in step 5 appears at the point where the green cursor is positioned in the character display area, after which the cursor moves to the next position.

The cursor moves to this position.

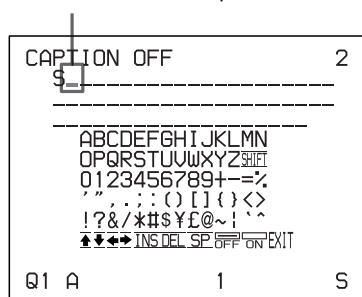

### When you enter the wrong character in the above example

- 1 Select ⇨ by pressing the ⇧, ⇩, ⇨ or ⇩ button, then press the EXEC button.

The cursor moves back by one and the character entered in step 5 is highlighted in green.

- 2 Select DEL by pressing the ⇧, ⇩, ⇨ or ⇩ button.

Highlight DEL in green by pressing the ⇧, ⇩, ⇨ or ⇩ button. DEL blinks in green.

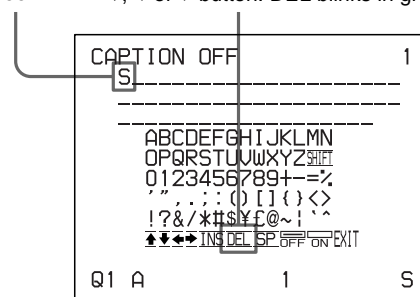

- 3 Press the EXEC button.

The character selected in 1 is deleted. When the character to be deleted is located among previously entered characters, the characters after the deleted one shift back by one.

#### Note

After the EXEC button is pressed, the monitor screen may become dark for a moment.

- 7 Repeat steps 4, 5 and 6 to enter the remaining characters of the caption.

### To enter a space

- 1 Position the green cursor at the point where you want to enter a space.
- 2 Select SP by pressing the ⇧, ⇩, ⇨ or ⇩ button.
- 3 Press the EXEC button.

A single space is entered and the green cursor moves to the next position.

If there is a character at the position where the space is entered, that character is deleted and a single space is left.

### To replace a previously entered character without changing the number of characters

You can replace a previously entered character with a new one.

- 1 Position the green cursor at the character to be replaced by performing the operations explained in step 4.
- 2 Overwrite the invalid character with the correct character by performing the operations explained in steps 5 and 6. The previously entered character is replaced with the new one.

### To add characters midway

- 1 Position the cursor at the position where a character is to be added by performing the operations explained in step 4.

- ② Select INS by pressing the  $\uparrow$ ,  $\downarrow$ ,  $\leftarrow$  or  $\rightarrow$  button. Then press the EXEC button. A single space is inserted between characters and the cursor is positioned at the space.
- ③ Enter the character to be added. When it is necessary to change the CAPTION ON/OFF setting, go to step 8. If not, go to step 9.

**Example: Add a character between A and B.**

- ① Move the cursor to B. (B is highlighted in green.)

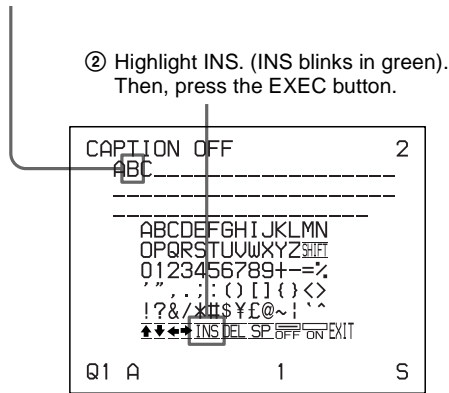

A single space is inserted between A and B and the green cursor is positioned at the space.

Cursor (lit in green)

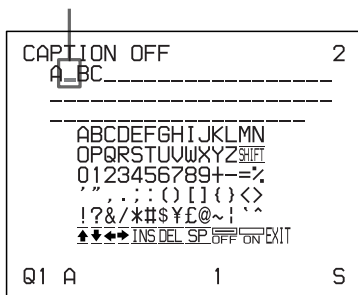

**Note**

After the EXEC button is pressed, the monitor screen may go dark for a moment.

- 8 Set the CAPTION ON/OFF function to ON.

- ① Select ON by pressing the  $\uparrow$ ,  $\downarrow$ ,  $\leftarrow$  or  $\rightarrow$  button.

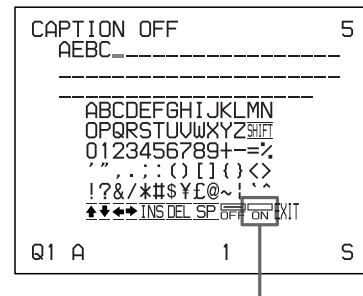

Highlight ON by pressing the  $\uparrow$ ,  $\downarrow$ ,  $\leftarrow$  or  $\rightarrow$  button. ON blinks in green.

Select OFF to make printouts without a caption.

- ② Press the EXEC button. The display changes from OFF to ON.

The display changes from OFF to ON.

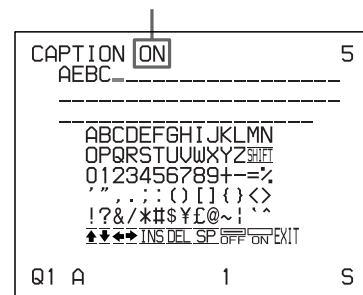

- 9 After entering the caption, highlight EXIT by pressing the  $\uparrow$ ,  $\downarrow$ ,  $\leftarrow$  or  $\rightarrow$  button, then press the EXEC button. The entered characters are stored in memory. The LAYOUT SETUP menu appears.

- 10 Press the MENU button.

**Note**

If you turn off the printer before performing the operation in step 9, characters entered in steps 4 to 7 are cleared without being stored in memory.

# Deleting Images Stored in Memory

You can delete images captured to memory pages, from either all of the memory pages or a single memory page, by using the CLEAR button.

Whether the images of all memory pages or only a single memory page are deleted depends on the setting of CLEAR in the FUNCTION SETUP menu.

## Setting the Function of the CLEAR Button

- 1 Display the FUNCTION SETUP menu according to the operations of steps 1 to 3 described in “Deciding which image is displayed on the video monitor screen after capturing an image” on page 27.
- 2 Select CLEAR by pressing the  $\uparrow$  or  $\downarrow$  button.

Position the cursor at CLEAR by pressing the  $\uparrow$  or  $\downarrow$  button.

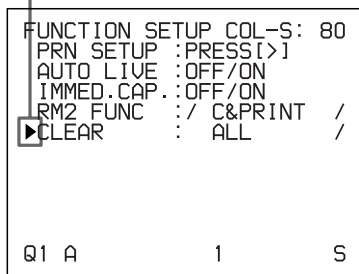

- 3 Select the function of the CLEAR button by pressing the  $\leftarrow$  or  $\rightarrow$  button.

Switch the desired function to green by pressing the  $\leftarrow$  or  $\rightarrow$  button.

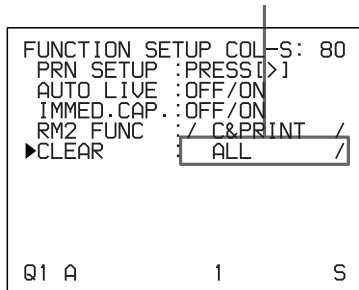

When you want to	Settings
Delete images of all memory pages.	ALL
Delete images of a single memory page.	PAGE
Deactivate the CLEAR button.	OFF

- 4 Select PRN SETUP by pressing the  $\uparrow$  or  $\downarrow$  button. Then, press the  $\rightarrow$  button. The PRINTER SETUP menu appears. Once you set the function of the CLEAR button, the CLEAR button functions according to the setting until the function setting is changed.

### To return to the regular screen

Press the MENU button.

## Deleting Images Stored in Memory

### Note

You cannot restore images once they have been deleted.

### Deleting images in all memory pages simultaneously

#### Before deleting images in all memory pages

Set CLEAR to ALL in the FUNCTION SETUP menu.

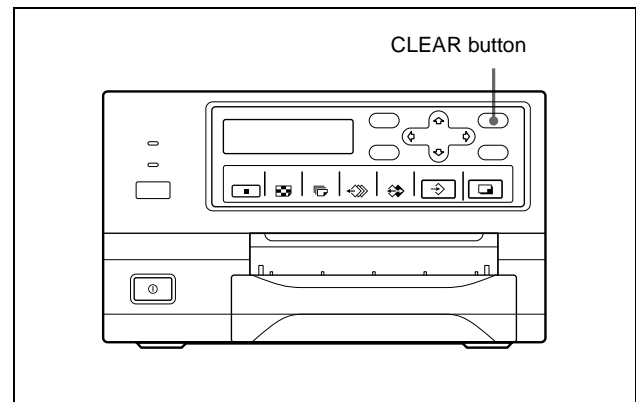

Press the CLEAR button.

All images captured in the printer are cleared.

### Notes

- Even if you press the CLEAR button when the source image is displayed on the video monitor, the memory image appears without deleting images in the memory pages. In this case, press the CLEAR button again. All images stored in the printer are cleared.
- An image which is being printed and the images queued in the memories cannot be cleared.

## Deleting images in a certain memory page

### Before deleting images

Set CLEAR to PAGE in the FUNCTION SETUP menu.

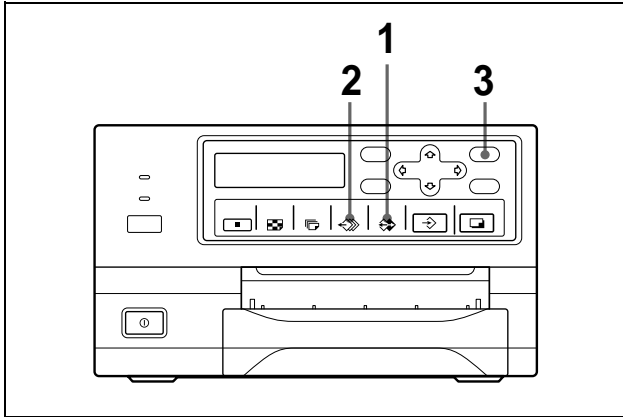

- 1** Press the SOURCE/MEMORY button when the source image is displayed on the video monitor screen.  
The image captured in memory is displayed on the screen.
- 2** Select the memory page from which images are to be deleted by pressing the MEMORY PAGE button.
- 3** Press the CLEAR button.  
The image in the memory page selected in step 2 is deleted.

## Erasing the Screen Display on the Video Monitor

You can erase characters displayed on the video monitor (Q1, A and so on) when, for example, it is hard to see the image that is hidden behind the screen display. The printer operation is the same, regardless of whether those characters are displayed on the video monitor. Since the same characters are displayed in the printer window display for the UP-21MD, perform operations watching them in the printer window display. For detailed information on displaying the type and remaining amount of the ink ribbon, see “Displaying the Type and Remaining Amount of the Ink Ribbon” on page 54.

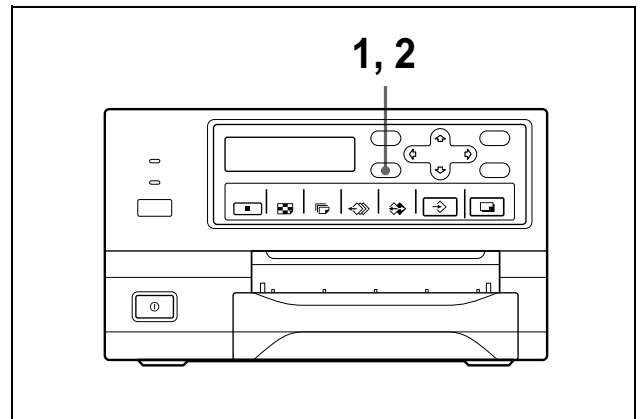

- 1** Press the DISPLAY button.  
The current setting appears. The video monitor screen is reset to the regular screen after a few seconds.

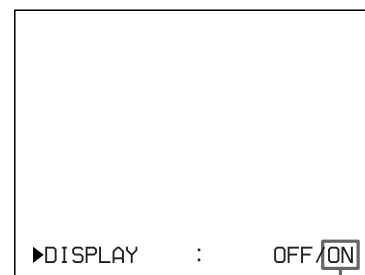

The currently selected setting is lit in green.

- 2** Select OFF.  
While the screen which appears in step 1 is displayed, press the DISPLAY button repeatedly until the color of OFF turns green on the video monitor, or until OFF is displayed in capital letters in the printer window display (for the UP-21MD).

Each time you press the DISPLAY button, the setting changes in the following sequence: ON → OFF → ON....

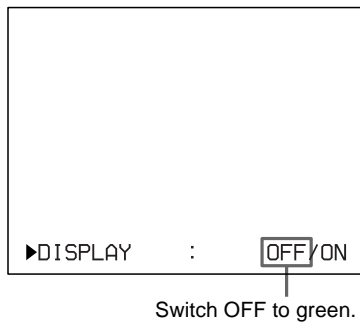

**To display characters on the video monitor**  
Select ON.

**To perform the setting for the monitor display on the menu**

You can also set whether characters are displayed on the video monitor by changing DISPLAY to ON or OFF in the OUTPUT SETUP menu. The setting of the DISPLAY button also changes according to the setting of DISPLAY in the OUTPUT SETUP menu, and vice versa.

**When you want to see an image that is hidden below a menu**

You can erase the menu temporarily while holding the DISPLAY button down.

**Note**

The error messages are always displayed regardless of the setting of the monitor display.

## Functions That Can be Set on Menus

You can set up the printer to meet various specifications. Once you have adjusted and stored the settings, the printer operates according to those settings until their values are modified. You can set up the printer according to its intended purpose, connected equipment, or your individual preferences.

You can store up to three settings as a set of user settings, called user set 1, 2 and 3.

Functions that can be set on those menus are as follows:

Menu	Functions to be set	Reference pages
COLOR ADJUST	Adjusting the printout color (color intensity and contrast) and sharpness	45
	LAYOUT SETUP	Selecting the memory mode 24 Selecting the type of printout 25 Selecting whether or not white borders are added to multiple reduced images 30
WINDOW SETUP	Eliminating the black lines produced on the printout	47
CAPTION	Entering a caption	31
PRINTER SETUP	Setting the print quantity	20
	Adjusting the tone of the printout	47
	Selecting the print speed	19
	Confirming whether or not the memory image is blurred	29
COLOR BALANCE	Adjusting the color balance	48
SYSTEM SETUP	Adjusting the brightness of the printer window display <sup>a)</sup>	53
	Setting the baud rate for computer communication	54
	Selecting whether or not the operation and error tones sound	53
	Compensating for the level of the input signal	43
	Registering user settings	54
USER NAME	Editing the user name	54

Menu	Functions to be set	Reference pages
FUNCTION SETUP	Selecting the image which appears after storing the image into memory, the source image or the memory image	27
	Selecting the timing of the pulse signal input to the REMOTE 2 connector	52
	Assigning the function to remote control units connected to the REMOTE 2 connector	52
	Setting the function of the CLEAR button	35
INPUT SETUP	Selecting the input signal	15
	Compensating for the input signals	43
OUTPUT SETUP	Erasing the screen display	36
	Matching the video monitor color to the printout color	44
	Selecting the output signal from the printer	44
	Selecting whether the printer synchronizes with the internal sync signal included in channel G of the RGB signals <sup>a)</sup>	11
	Selecting whether or not information about the ink ribbon is displayed	54

a) Only for the UP-21MD

# Menu Tree

Regular screen



Press the MENU button.

For reference pages of each menu, see the table on "Functions That Can be Set on Menus" on page 38.

## COLOR ADJUST menu

```
COLOR ADJUST COL-S: 80
▶/COL/LAY/PRN/IN/OUT/
LOAD COLOR: 1/2/3 TEMP
CYN - RED : 0 .....|.....
MAG - GRN : 0 .....|.....
YEL - BLU : 0 .....|.....
DARK      : 0 .....|.....
LIGHT     : 0 .....|.....
SHARPNESS : 8 .....|.....
INTERPOL. : OFF/ON
SAVE COLOR: 1/2/3 [EXEC]
Q1 A      1      S
```

## WINDOW SETUP menu

```
WINDOW SETUP COL-S: 80
▶LAY SETUP :PRESS[>]
H START   : 0 DOT(S)
V START   : 0 DOT(S)
H WIDTH   : 936 DOTS
V WIDTH   : 472 DOTS
SAVE      :PRESS[EXEC]
CANCEL   :PRESS[EXEC]
Q1 A      1      S
```

## LAYOUT SETUP menu

```
LAYOUT SETUP COL-S: 80
▶/COL/LAY/PRN/IN/OUT/
MEMORY    :FRAME/FIELD
MULTI PIX : 1/2/4
SEPARATE  :OFF/ON
WINDOW    :PRESS[>]
CAPTION   :PRESS[>]
Q1 A      1      S
```

## CAPTION menu

```
CAPTION OFF 1
-----
ABCDEFGHIJKLMN
OPQRSTUVWXYZ
0123456789+-=
: : : ( [ ] { } < >
! ? & / * # $ % ^ @ ~ ! ^
*** INS DEL SP OFF GR EXIT
Q1 A      1      S
```

## PRINTER SETUP menu

```
PRINTER SETUP COL-S: 80
▶/COL/LAY/PRN/IN/OUT/
PRINT QTY.: 1 [1~9]
GAMMA     :S/NORMAL/H
PRN SPEED :NORMAL/HIGH
MOTION CHK:OFF/ON
LOAD USER : 1/2/3 [EXEC]
SYSTEM    :PRESS[>]
FUNCTION  :PRESS[>]
C-BALANCE :PRESS[>]
Q1 A      1      S
```

## SYSTEM SETUP menu

```
SYSTEM SETUP COL-S: 80
▶PRN SETUP :PRESS[>]
LCD-CNTR. : 7 .....|.....
BAUDRATE  :/24/48/9600
BEEP       :OFF/ON
IRE        :100/11/12/13
SAVE USER : 1/2/3 [EXEC]
USER NAME  :PRESS[>]
Q1 A      1      S
```

## INPUT SETUP menu

```
INPUT SETUP COL-S: 80
▶/COL/LAY/PRN/IN/OUT/
INPUT SEL :U/SV/RGB
HUE       : * * * * *
COLOR     : * * * * *
GAIN      : 0 .....|.....
OFFSET    : 0 .....|.....
AGC       : OFF/ON
Q1 A      1      S
```

## USER NAME menu

```
USER NAME 1
-----
ABCDEFGHIJKLMN
OPQRSTUVWXYZ
0123456789+-=
: : : ( [ ] { } < >
! ? & / * # $ % ^ @ ~ ! ^
*** INS DEL SP EXIT
Q1 A      1      S
```

## OUTPUT SETUP menu

```
OUTPUT SETUP COL-S: 80
▶/COL/LAY/PRN/IN/OUT/
DISPLAY   :OFF/ON
RBN REMAIN:OFF/ON
SOURCE    :THRU/EE
SYNC ON G :OFF/ON
MONI C-R  : 0 .....|.....
MONI M-G  : 0 .....|.....
MONI Y-B  : 0 .....|.....
Q1 A      1      S
```

## FUNCTION SETUP menu

```
FUNCTION SETUP COL-S: 80
▶PRN SETUP :PRESS[>]
AUTO LIVE  :OFF/ON
IMMED.CAP. :OFF/ON
RM2 FUNC   : / C&PRINT /
CLEAR      : ALL /
Q1 A      1      S
```

## COLOR BALANCE menu

```
COLOR BALANCE COL-S: 80
▶PRN SETUP :PRESS[>]
BAL X      :50 [1~99]
BAL Y      :50 [1~99]
BAL STEP   :05 [1~20]
TEST PRINT :PRESS[EXEC]
Q1 A      1      S
```

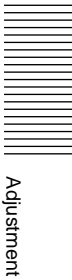

Adjustment

# Basic Menu Operations

In this section, in addition to the video monitor display, the printer window display is also introduced. Since the UP-20 is not equipped with a printer window display, ignore the advice pertaining to the printer window display when you use the UP-20.

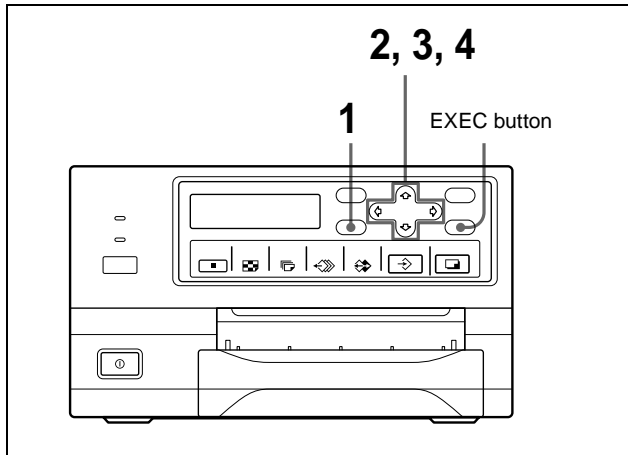

- 1 Press the MENU button.  
The previously selected menu appears.

The menu currently displayed on the screen is lit in green.

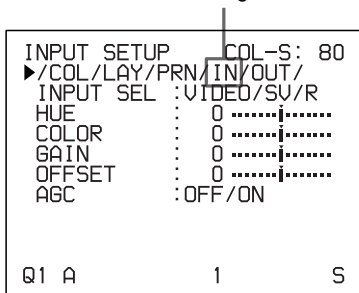

The name of the menu currently displayed appears in capital letters.

When the cursor is not positioned on the top line (where you can select the desired menu):

Move the cursor to the top line by pressing the  $\uparrow$  or  $\downarrow$  button.

The cursor is not positioned on the top line.

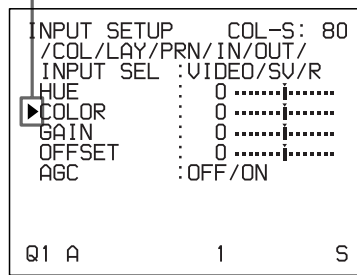

- 2 Display the desired menu by pressing the  $\leftarrow$  or  $\rightarrow$  button.

**Example: To display the PRINTER SETUP menu**

Switch PRN to green by pressing the  $\leftarrow$  or  $\rightarrow$  button, then the PRINTER SETUP menu appears.

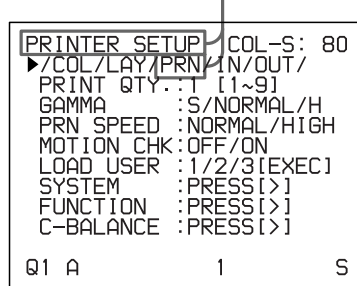

Display PRN in capital letters by pressing the  $\leftarrow$  or  $\rightarrow$  button. The PRINTER SETUP appears.



- 3 Select the desired item by pressing the  $\leftarrow$  or  $\rightarrow$  button.

**Example: To select PRN SPEED on the PRINTER SETUP menu**

Position the cursor at PRN SPEED by pressing the  $\leftarrow$  or  $\rightarrow$  button.

```

PRINTER SETUP COL-S: 80
/COL/LAY/PRN/IN/OUT/
PRINT QTY.: 1 [1~9]
GAMMA : S/NORMAL/H
▶PRN SPEED : NORMAL/HIGH
MOTION CHK: OFF/ON
LOAD USER : 1/2/3[EXEC]
SYSTEM :PRESS[>]
FUNCTION :PRESS[>]
C-BALANCE :PRESS[>]

Q1 A 1 S
  
```

```

PRN SPEED :
NORMAL/high
  
```

Press the  $\leftarrow$  or  $\rightarrow$  button until PRN SPEED appears.

- 4 Change the setting by pressing the  $\leftarrow$  or  $\rightarrow$  button.

**To change the selection:**

Switch the desired selection to green by pressing the  $\leftarrow$  or  $\rightarrow$  button.

**Note**

When / is displayed at both ends of a selection or at either the right or left end, there are more selections in this direction. Press the  $\leftarrow$  or  $\rightarrow$  button to display more selections.

**Example: To select HIGH of the PRN SPEED item on the PRINTER SETUP menu**

Switch HIGH to green by pressing the  $\leftarrow$  or  $\rightarrow$  button.

```

PRINTER SETUP COL-S: 80
/COL/LAY/PRN/IN/OUT/
PRINT QTY.: 1 [1~9]
GAMMA : S/NORMAL/H
▶PRN SPEED : NORMAL/HIGH
MOTION CHK: * * * * *
LOAD USER : 1/2/3[EXEC]
SYSTEM :PRESS[>]
FUNCTION :PRESS[>]
C-BALANCE :PRESS[>]

Q1 A 1 S
  
```

```

PRN SPEED :
normal/HIGH
  
```

Display HIGH in capital letters by pressing the  $\leftarrow$  or  $\rightarrow$  button.

**When \*\*\*\*\* is displayed at the selection:**

\*\*\*\*\* is displayed when changing the selection is ineffective. The following table lists the case where the selection is ineffective.

Selected item	Item can not be changed (when ***** is displayed at the selection)
1 is selected for MULTI PIX on the LAYOUT SETUP menu.	SEPARATE (LAYOUT SETUP menu) MOTION CHK (PRINTER SETUP menu)
RGB is selected for INPUT SEL on the INPUT SETUP menu <sup>a)</sup> .	HUE (INPUT SETUP menu) COLOR (INPUT SETUP menu)
ON is selected for IMMED.CAP on the FUNCTION SETUP menu.	RM2 FUNC (FUNCTION SETUP menu)

a) Only for the UP-21MD

### To change the setting values:

Press the  $\leftarrow$  or  $\rightarrow$  button to decrease or increase the setting values.

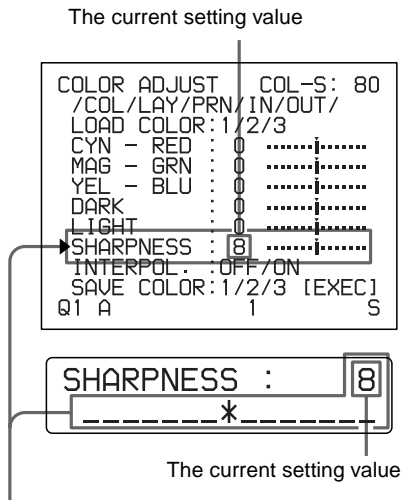

The setting value increases every time you press  $\rightarrow$  button.  
The setting value decreases every time you press the  $\leftarrow$  button.

### To reset the values to factory setting:

Position the cursor at the item to be reset to defaults, then press the  $\leftarrow$  and  $\rightarrow$  buttons simultaneously.

### When there are sub menus:

When there are sub menus, PRESS [>] is displayed on the selection part of the menu. Select the desired sub menu by pressing the  $\uparrow$  or  $\downarrow$  button, then press the  $\rightarrow$  button.

### Example: On the PRINTER SETUP menu

To display the SYSTEM SETUP sub menu:  
Select SYSTEM by pressing the  $\uparrow$  or  $\downarrow$  button, then press the  $\rightarrow$  button.

The SYSTEM SETUP menu appears.

Position the cursor at SYSTEM by pressing the  $\uparrow$  or  $\downarrow$  button, then press the  $\rightarrow$  button.

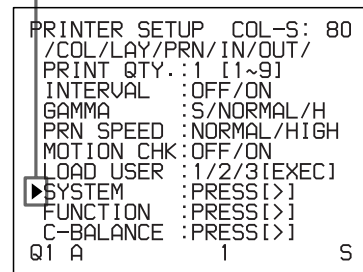

Press the  $\uparrow$  or  $\downarrow$  button until SYSTEM appears, then press the  $\rightarrow$  button.

### To return from the sub menu:

Select the menu, then press the  $\rightarrow$  button.

# Adjusting the Color and Picture Quality

## Compensating for the Input Signals

A video image recorded under poor conditions may be of poor color quality. If the signal is an NTSC or PAL composite video signal or separate luminance (Y) and chrominance (C) signals, you can correct the color and level of the input signal to a certain extent.

### Note

You cannot adjust an image once it has been captured in memory. If you want to make adjustments, capture that image again, after making the adjustment.

### Confirmation

When the memory image is displayed on the video monitor, press the SOURCE/MEMORY button to display the image from the video source.

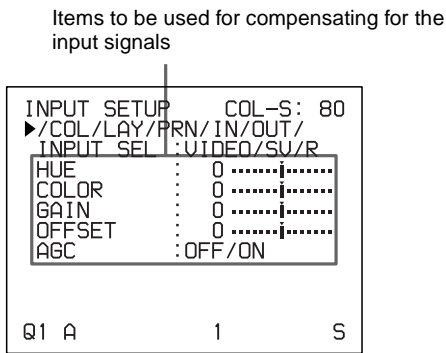

## To adjust the color intensity, hue, contrast and brightness

Adjustment	Menu adjustment item	Button to be pressed and result of the operation	
		⇐ button	⇒ button
Hue	HUE <sup>a), b)</sup>	The hue becomes purplish.	The hue becomes greenish.
Color intensity	COLOR <sup>b), c)</sup>	The color intensity weakens.	The color intensity strengthens.
Contrast	GAIN <sup>d)</sup>	The contrast weakens.	The contrast strengthens.
Brightness	OFFSET	Becomes darker.	Becomes brighter.

a) In PAL mode, no HUE adjustment is provided on the INPUT SETUP menu.

- b) Adjust the color such that skin tones appear natural. For the COLOR and HUE adjustment, you can correct the color intensity and hue of an NTSC composite video signal or a separated luminance (Y) and chrominance (C) signal.
- c) On a setting of step -14, OFF appears and the image, displayed on the video monitor, becomes black and white.
- d) To perform adjustment of GAIN, set AGC (explained below) to OFF.

## When the printout or monitor image appears blackish or whitish

Adjust the input signal to the optimum level for printing.

Menu adjustment item	Selection	When
AGC (Automatic Gain Control)	ON <sup>a)</sup>	The printout or monitor image appears blackish or whitish.
	OFF	The proper signal is input. (Normal)

a) If you think that the AGC adjustment is not satisfactory, you can perform fine adjustment using the GAIN item.

## Adjusting the contrast of printouts

When you want to change the contrast of printouts without changing the contrast of the video monitor, compensate for the level of the input signal using the IRE item in the SYSTEM SETUP menu.

Items to be used when adjusting the contrast of printouts

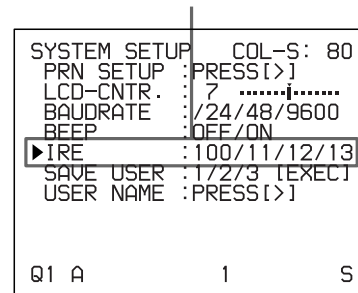

The selected IRE is displayed in three digits.

When	IRE value
Resetting to the standard adjustment	10 → 100
The printout is a little whitish.	11 → 110
The printout is whitish.	12 → 120
The printout is very whitish.	13 → 130

### Note

Do not compensate for the input signal too much. Doing so results in the whole of the printout becoming dark.

Adjustment

# Matching the Video Monitor Color to the Printer Color

To match the color of the monitor image to that of the printout, adjust the monitor and printer colors such that the monitor color is the same as that of the printout. The printer outputs either of two kinds of video signals based on the printer settings.

- EE (E to E): Signals are output to the monitor after being processed by the printer’s circuitry.
- THRU (THROUGH): Signals are output to the monitor as is.

## Adjustment on the video monitor

The monitor color may not be adjusted correctly even if the printer color is correctly adjusted. Check the color of the video monitor before adjusting the printout color. In such a case, use the THRU signal by setting SOURCE to THRU on the OUTPUT SETUP menu or turning off the power of the printer to send out the through signal from the video equipment to the video monitor.

After adjusting the color of the video monitor using video monitor controls, adjust the color of the printer’s output signal.

## Adjustment on the printer

### Note

This adjustment is performed to adjust the color of the printer output signal when the monitor color is unsatisfactory. This adjustment does not affect the printout itself. To adjust the color of the printout, see “Adjusting the Printout Color” on page 45.

- 1 Display the OUTPUT SETUP menu.

OUTPUT SETUP menu

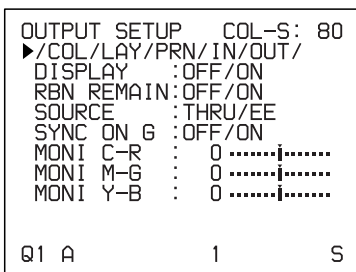

- 2 Select SOURCE by pressing the ⬆ or ⬇ button.
- 3 Select EE by pressing the ⬅ or ➡ button.
- 4 Press the MENU button.  
The regular screen appears.

- 5 Capture a new image in memory and make a printout.  
Adjust the settings on the printer side by comparing the printout with the image on the monitor, as follows.
- 6 Display the OUTPUT SETUP menu again.
- 7 Adjust the monitor while comparing the printout with the image on the monitor.

Menu adjustment item	When you want to	Button to be pressed	Adjustment direction on the menu
MONI C-R	Make the screen more reddish.	⇒ button	Toward RED
	Make the screen become cyan (blue).	⇐ button	Toward CYN (cyan)
MONI M-G	Make the screen more greenish.	⇒ button	Toward GRN (green)
	Make the screen become magenta (pink).	⇐ button	Toward MAG (magenta)
MONI Y-B	Make the screen more bluish.	⇒ button	Toward BLU (blue)
	Make the screen more yellowish.	⇐ button	Toward YEL (yellow)

Select the desired item, then perform the adjustment.

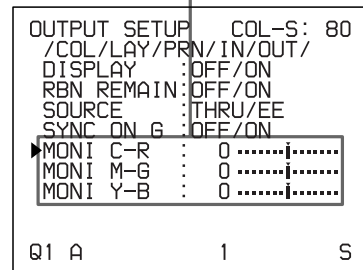

# Adjusting the Printout Color

You can adjust the printout quality by adjusting the color intensity, printout contrast and sharpness and tone (GAMMA) of the printout.

## Adjusting the color intensity, contrast and sharpness

You can store up to three types of settings and manage these settings using the LOAD COLOR numbers 1, 2 and 3. The color intensity, picture contrast and sharpness of a printout are determined by recalling one of the three settings according to their LOAD COLOR numbers.

This is useful when you are using more than one item of video equipment, each having different characteristics, when you want to print images having different color qualities and picture contrast, or when multiple users access a single printer.

Also, you can make a printout using temporarily set values, without clearing the stored adjustment values. Perform the adjustments while viewing the images captured in memory.

**1** Display the COLOR ADJUST menu.

COLOR ADJUST menu

```

COLOR ADJUST   COL-S: 80
▶/COL/LAY/PRN/IN/OUT/
LOAD COLOR: 1/2/3  TEMP
CYN - RED : 0 .....|.....
MAG - GRN : 0 .....|.....
YEL - BLU : 0 .....|.....
DARK      : 0 .....|.....
LIGHT     : 0 .....|.....
SHARPNESS : 8 .....|.....
INTERPOL. : OFF/ON
SAVE COLOR: 1/2/3 [EXEC]
Q1 A      1      S
    
```

**2** Select the LOAD COLOR number of the values to be adjusted or to be modified by pressing the ⇄ or ⇨ button.

When modifying, you can preserve the original settings. (See “To retain the originally set value” on page 46.)

**3** Adjust the printout color.

Items to be used for adjusting the color intensity

```

COLOR ADJUST   COL-S: 80
/ COL/LAY/PRN/IN/OUT/
LOAD COLOR: 1/2/3  TEMP
▶CYN - RED : 0 .....|.....
MAG - GRN : 0 .....|.....
YEL - BLU : 0 .....|.....
DARK      : 0 .....|.....
LIGHT     : 0 .....|.....
SHARPNESS : 8 .....|.....
INTERPOL. : OFF/ON
SAVE COLOR: 1/2/3 [EXEC]
Q1 A      1      S
    
```

Items to be used for adjusting the contrast

```

COLOR ADJUST   COL-S: 80
/ COL/LAY/PRN/IN/OUT/
LOAD COLOR: 1/2/3  TEMP
CYN - RED : 0 .....|.....
MAG - GRN : 0 .....|.....
YEL - BLU : 0 .....|.....
▶DARK      : 0 .....|.....
LIGHT     : 0 .....|.....
SHARPNESS : 8 .....|.....
INTERPOL. : OFF/ON
SAVE COLOR: 1/2/3 [EXEC]
Q1 A      1      S
    
```

```

COLOR ADJUST   COL-S: 80
/ COL/LAY/PRN/IN/OUT/
LOAD COLOR: 1/2/3  TEMP
CYN - RED : 0 .....|.....
MAG - GRN : 0 .....|.....
YEL - BLU : 0 .....|.....
DARK      : 0 .....|.....
LIGHT     : 0 .....|.....
▶SHARPNESS : 8 .....|.....
INTERPOL. : OFF/ON
SAVE COLOR: 1/2/3 [EXEC]
Q1 A      1      S
    
```

Items to be used for adjusting the sharpness/interpolation

### To adjust the color intensity (RED/GREEN/BLUE)

The RED, GREEN and BLUE color component settings are divided into 15 steps, from -7 to +7, indicated by a value and graph. The center of the graph (0) corresponds to the standard setting.

Menu Adjustment item	When you want to	Button to be pressed	Adjustment direction on the menu
CYN-RED	Make the image reddish.	⇨ button	Toward RED
	Make the image cyan.	⇄ button	Toward CYN (cyan)

Adjustment

Menu Adjustment item	When you want to	Button to be pressed	Adjustment direction on the menu
MAG-GRN	Make the image greenish.	⇒ button	Toward GRN (green)
	Make the image magenta (pink).	⇐ button	Toward MAG (magenta)
YEL-BLU	Make the image bluish.	⇒ button	Toward BLU (blue)
	Make the image yellowish.	⇐ button	Toward YEL (yellow)

### To adjust the contrast (DARK/LIGHT)

The contrast settings are divided into 15 steps, from -7 to +7, indicated by a value and graph. The center of the graph (0) corresponds to the standard setting.

Adjustment item	When you want to
DARK	Adjust the dark area of an image.
LIGHT	Adjust the light area of an image.

### To adjust the sharpness (SHARPNESS/INTERPOL.)

#### SHARPNESS:

You can set the sharpness to any of 15 steps from 1 to 15. A setting of step 8 corresponds to the standard sharpness (default setting).

When you want to	Content of settings
Make a soft outline.	To the left (toward step 1)
Make a normal outline.	Centered (step 8)
Make a sharp outline.	To the right (toward step 15)

#### INTERPOL. (Interpolation):

You can select either ON or OFF depending on the type of image.

When you want to	Setting
Print out image data such as a figure image or a landscape.	ON
Print out image data of computer graphics or of an image with small letters.	OFF

#### Note

The effectiveness of SHARPNESS may differ between ON and OFF settings of INTERPOL.

### Once you have changed the value

Once you have changed the value, TEMP (TEMPORARY) appears on the menu screen. TEMP indicates that the settings are temporary and have not yet been stored. If you turn off the power of the printer while TEMP is displayed, the adjusted values are not stored.

- 4 Select the SAVE COLOR number to which new settings are to be stored using the SAVE COLOR item.

### To retain the originally set value

Select a SAVE COLOR number which is different from the LOAD COLOR number selected in step 2.

- 5 Press the EXEC button.  
The settings are registered in the SAVE COLOR number selected in step 4.  
TEMP disappears from the menu.  
**To continue settings for another LOAD COLOR number:** Repeat steps 2 to 5.  
**To finish the setting:** Press the MENU button.  
The regular screen appears.

### To copy the settings made for one LOAD COLOR number to another LOAD COLOR number

- 1 Select the source LOAD COLOR number for which the settings to be copied are stored on the COLOR ADJUST menu.
- 2 Select the target SAVE COLOR number to which data is to be copied.
- 3 Press the EXEC button.  
Settings stored for the LOAD COLOR number selected in step 1 are copied to the SAVE COLOR number selected in step 2.

### To recall the LOAD COLOR number in which printout color settings (color intensity, contrast and sharpness) are stored

Switch the desired LOAD COLOR number to green on the COLOR ADJUST menu. On the printer window display, display the desired LOAD COLOR number. The settings of the currently selected LOAD COLOR number are displayed.  
The printout is made according to the setting of the selected LOAD COLOR number as long as you do not modify those settings.

## Adjusting the tone of the printout

You can adjust the tone so that the details in the white or black part are clearly printed.

- 1 Display the PRINTER SETUP menu.

PRINTER SETUP menu

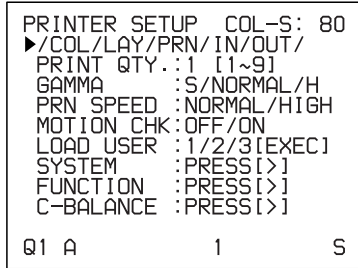

- 2 Select GAMMA, and then the desired tone. The selected tone is spelled out.

When you want to	Setting
Make a printout of an image where there are a lot of white or light-colored areas.	S → SOFT
Make a printout of a normal image.	N → NORMAL
Make a printout of an image where there are a lot of black or dark-colored areas.	H → HARD

## When a Black Frame or Lines Show up on the Printouts

When you print an image that is narrower or wider than the standard screen size, a black frame may be printed or the image may be partially cut. Or, a black line may show up on the printout even though it does not appear on the video monitor. Any portion for which there is no video signal is printed in black. This may occur when you make printouts after connecting a different video source or play back using different video software. In such a case, you can adjust the printout area by moving the screen either horizontally or vertically.

### Note

This adjustment affects only the input signal. This adjustment does not affect the image captured in the memory.

- 1 Display the WINDOW SETUP menu from the LAYOUT SETUP menu.

### Note

When the WINDOW SETUP menu appears, the images stored in the memory will be cleared.

- 2 Perform adjustments according to the printout obtained by using the V START, V WIDTH, H START and H WIDTH items.

Item to be used for eliminating the vertical line at the right side

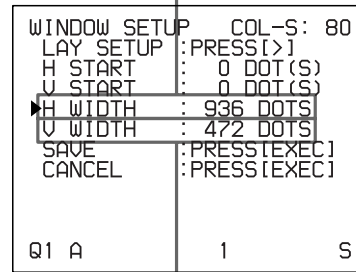

Item to be used for eliminating the horizontal line on the bottom

Item to be used for eliminating the vertical line at the left side

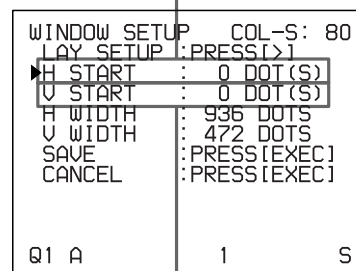

Item to be used for eliminating the horizontal line at the top

## When a horizontal black line is produced on the printout

### To eliminate a horizontal black line produced at the top:

Adjust the top position of the image to be printed using the V START item.

### Note

It is alright if a black line appears at the bottom while you adjusting the top. You can eliminate it using the V WIDTH item.

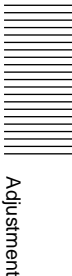

Adjustment

**To eliminate a horizontal black line produced at the bottom:**

Adjust the bottom position of the image to be printed using the V WIDTH item.

**Note**

If you enlarge the bottom position by pressing the ⇨ button even though there is no video signal, the value of V START may be changed. This results in a black line appearing at the top.

**When a vertical black line is produced on the printout****To eliminate a vertical black line produced on the left side:**

Adjust the left position of the image to be printed using the H START item.

**Note**

It is alright if a black line appears on the right side while you adjusting on the left side. You can eliminate it using the H WIDTH item.

**To eliminate a vertical black line produced on the right side:**

Adjust the right position of the image to be printed using the H WIDTH item.

**Note**

If you enlarge the right side position by pressing the ⇨ button even though there is no video signal, the value of H START may be changed. This results in a black line appearing on the left side.

**To reset the values to defaults**

For H START, H WIDTH, V START and V WIDTH items, you can reset the values to defaults in pairs.

To reset the values for vertical settings, position the cursor at either V START or V WIDTH, and then press the ⇐ and ⇨ buttons simultaneously.

To reset the values for horizontal settings, position the cursor at either H START or H WIDTH, and then press the ⇐ and ⇨ buttons simultaneously.

	H WIDTH	H START	V WIDTH	V START
Defaults	NTSC/PAL: 936	NTSC/PAL: 0	NTSC:472, PAL: 556	NTSC/PAL: 0

- 3 Select SAVE, then press the EXEC button. The adjusted values are stored. The LAYOUT SETUP menu appears.

**To clear the adjusted value**

Select CANCEL in step 3, then press the EXEC button. The values adjusted in step 2 are cleared and the values are reset to the original ones.

**To check the adjustment result**

Capture a new image and print it to check that no black frame appears on the printout, that the image is not partially cut, and that no black line appears.

**Adjusting the Color Balance**

You should use the ink ribbon and paper that are contained in the same package as a pair. The color balance may differ depending on each pair. It is recommended that you adjust the color balance each time you load a new set of ink ribbon and paper.

**Before adjusting the color balance**

- Reset all items on the COLOR ADJUST menu to defaults. (See “Adjusting the Printout Color” on page 45.)
- Confirm that the source image is displayed. If not, display the source image on the video monitor by using the SOURCE/MEMORY button.

- 1 Display the COLOR BALANCE menu from the PRINTER SETUP menu.

```

PRINTER SETUP COL-S: 80
/COL/LAY/PRN/IN/OUT/
PRINT QTY.:1 [1~9]
GAMMA      :S/NORMAL/H
PRN SPEED  :NORMAL/HIGH
MOTION_CHK:OFF/ON
LOAD USER  :1/2/3[EXEC]
SYSTEM     :PRESS[>]
FUNCTION    :PRESS[>]
▶C-BALANCE :PRESS[>]
01 A          1          S
  
```

Select C-BALANCE, then press the ⇨ button.



The highlighted area on the COLOR BALANCE menu will be printed to be used for adjusting the color balance.

You can move this area to any place on the video monitor.

The area that will be captured in memory.  
(This area is highlighted and is one ninth the size of the whole screen.)

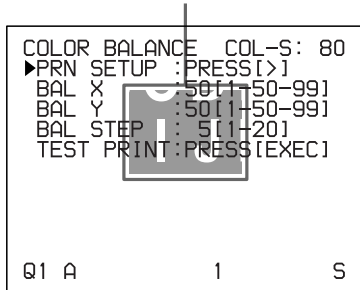

When you adjust the color balance for the first time after you purchase the printer, the values of BAL X, BAL Y and BAL STEP are set to 50, 50 and 05 at the factory setting.

When you have adjusted the color balance already, the values adjusted previously are displayed on the COLOR BALANCE menu.

The currently adjusted values of BAL X, BAL Y and BAL STEP  
On this COLOR BALANCE menu, the default values (factory settings) are displayed.

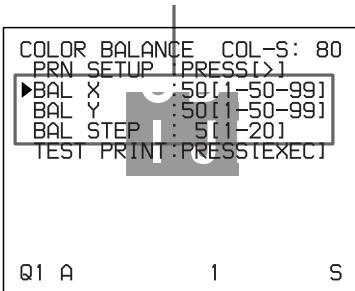

### To reset the values to the factory setting (50/50/05)

Select each item by pressing the  $\uparrow$  or  $\downarrow$  button, then press the  $\leftarrow$  and  $\rightarrow$  buttons at the same time. The currently selected item is reset to the default.

## 2 Decide the position of the source image to be used for adjusting the color balance.

To decide the position of the source image, move the highlighted area by pressing the  $\uparrow$ ,  $\downarrow$ ,  $\leftarrow$  or  $\rightarrow$  button while holding down the DISPLAY button.

Move the highlighted part to the desired image position by pressing the  $\uparrow$ ,  $\downarrow$ ,  $\leftarrow$  or  $\rightarrow$  button while holding down the DISPLAY button. (The COLOR BALANCE menu disappears temporarily.)

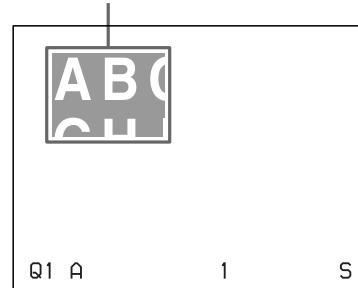

## 3 Press the CAPTURE button. The image captured in memory appears.

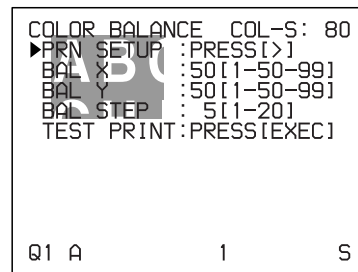

- 4** Select TEST PRINT by pressing the  $\uparrow$  or  $\downarrow$  button, then press the EXEC button. Nine identical images of the position selected in step 2 are printed on a sheet of paper as a test print. Each image has a different color balance.

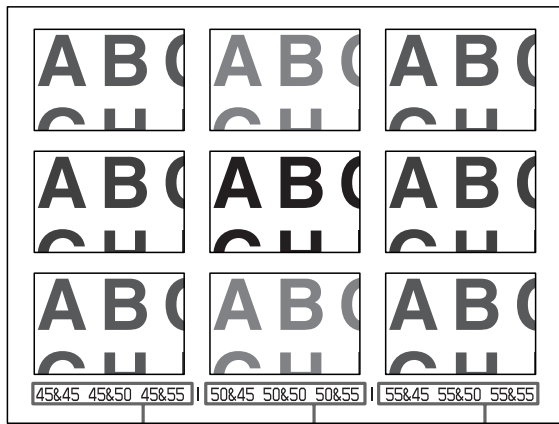

Indicates the color balance of the images printed in the left column. (From the top, 45 & 45, 45 & 50, 45 & 55)

Indicates the color balance of the images printed in the center column. (From the top, 50 & 45, 50 & 50, 50 & 55)

Indicates the color balance of the images printed in the right column. (From the top, 55 & 45, 55 & 50, 55 & 55)

Example of the actual color change in the test print

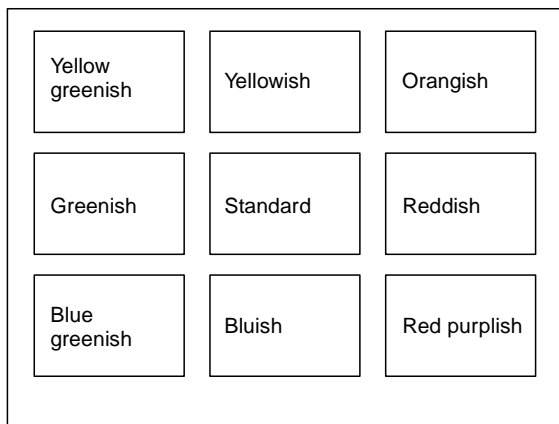

- 5** Select the image which has the best color balance among the nine images. If you want to change the color balance after you see the printout, adjust the color balance again, referring to "To readjust the color balance" on page 50.

- 6** Display the values of BAL X and BAL Y corresponding to the ones of the image selected in step 5 by using the  $\leftarrow$  or  $\rightarrow$  button. Example: When the color balance (55 & 45) of the image printed on the bottom left is the best:

Display 55 for BAL X and 45 for BAL Y by pressing the  $\leftarrow$  or  $\rightarrow$  button.

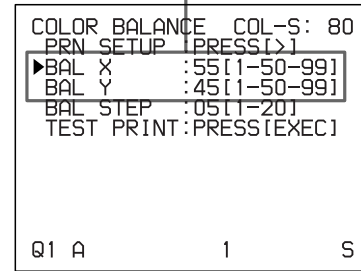

The color balance of the printed image has been adjusted to the values selected in step 5.

### To readjust the color balance

When the desired color balance cannot be obtained in step 5, readjust the color balance. You can also perform fine adjustment following the same operation procedures.

- 1** Display the values of BAL X and BAL Y of the image which is the most appropriate among nine images. In this case, you can perform either fine adjustment or a rough adjustment by changing the value of BAL STEP.

### To perform fine adjustment

To perform color balance adjustment within the current color balance range, reduce the value of BAL STEP.

If you change BAL STEP from 05 to 03, the color balances of the test print are changed as illustrated.

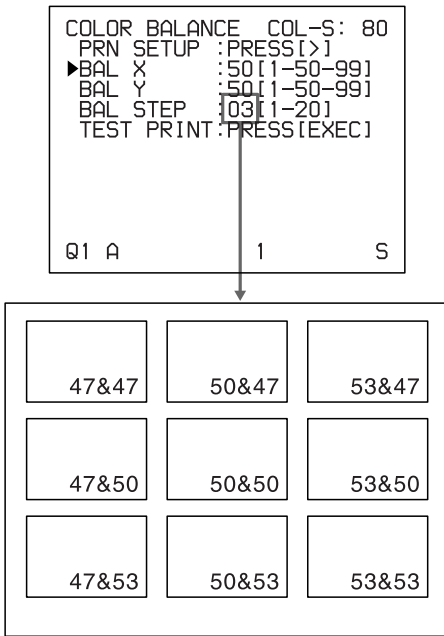

### To perform rough adjustment

To perform color balance adjustment beyond the current color balance range, increase the value of BAL STEP.

If you change BAL STEP from 05 to 10, the color balances of the test print are changed as illustrated.

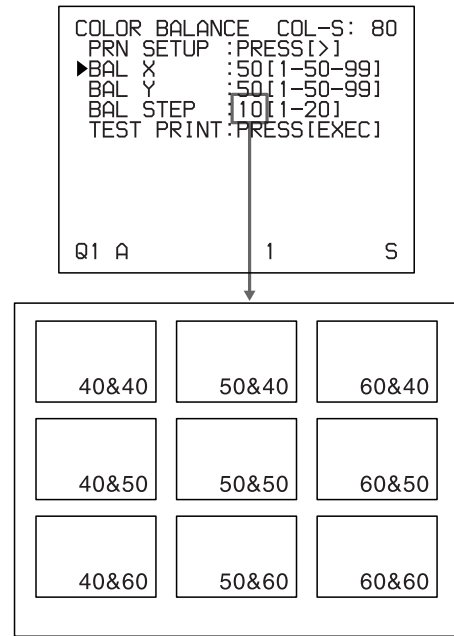

#### Note

The above illustration indicates the color balance when the balance step is changed from 05 to 03. However, on the actual printout, values of the color balance are not printed on each image. They are printed on the bottom of the printout.

- 2 Make a test print by repeating steps 2, 3 and 4 in “Adjusting the Color Balance” on page 48.
- 3 Select the image with the best color balance among the 9 images, if you can decide.  
If there is not the image with the best color balance, repeat steps 1 and 2 until you have obtained the best color balance.
- 4 Go back to step 6 in “Adjusting the Color Balance” on page 48.

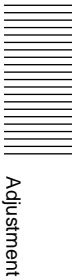

# Making Various Settings

## Assigning Functions to the Remote Control Unit

You can control the printer using the RM-91 Remote Control Unit (not supplied) connected to the REMOTE 2 connector on the rear panel of the printer.

Using the menu, you can assign the desired functions to the remote control unit connected to the REMOTE 2 connector.

In addition, the printer can be remotely controlled by a pulse signal input to REMOTE 2. (See page 59.)

Also, you can control the printer using a personal computer.

For detailed information on controlling the printer with a computer, contact with your Sony dealer.

- 1 Display the FUNCTION SETUP menu from the PRINTER SETUP menu.

```

FUNCTION SETUP COL-S: 80
▶PRN SETUP :PRESS[>]
AUTO LIVE :OFF/ON
IMMED.CAP.:OFF/ON
RM2 FUNC  :/ C&PRINT /
CLEAR     : ALL /

Q1 A      1      S
    
```

- 2 Select the timing to capture the image on the IMMED. CAP. item

When you want to	Selection
Capture the image just after the trigger pulse is input to the REMOTE 2 connector. <sup>a)</sup>	ON
Capture the image a certain interval after the trigger pulse is input to the REMOTE 2 connector. <sup>b)</sup>	OFF

- a) When IMMED. CAP. is set to ON, display the source image on the video monitor when sending the trigger pulse to the printer. The printer operation is set only to capture an image when receiving the trigger pulse.
- b) For detailed information on the timing for the REMOTE 2 connector, see page 59.

### Notes

- Select ON when you want to capture the image at a precise point in time controlled from the computer.
- To assign the function to the remote control unit connected to the REMOTE 2 connector on the

FUNCTION SETUP menu, set the IMMED.CAP item on the FUNCTION SETUP menu to OFF.

- 3 Select the desired RM 2 FUNC item, then assign a function.

Function to be selected	Operation
CAPTURE	Has the same function as the CAPTURE button on the printer.
PRINT	Has the same function as the PRINT button on the printer.
C & PRINT <sup>a)</sup> (CAPTURE & PRINT)	Captures an image to a memory page where there is not a queued image waiting to be printed and print them whenever you press the switch. If you press the switch while printing is being performed, the selected image is queued, with the queued image being printed once printing has been completed.
CYCLIC-C <sup>b)</sup> (CYCLIC CAPTURE)	Captures images to memory pages where there are no queued images. It does this cyclically whenever you press the switch. The printer continues to capture images, replacing the one previously captured with a new one.
CAP-STOP <sup>b)</sup> (CAPTURE STOP)	Captures images in a memory page whenever you press the switch of the remote control unit. Once images have been captured in all the memory pages, the printer stops capturing images and the message HIT ANY KEY appears.
STOP	Stops printing after the current printing operation is finished whenever you press the switch of the remote control unit.
CAP/SRC (CAPTURE/ SOURCE)	When the memory image is displayed, the source image appears when you press the switch. When the source image is displayed, the image is captured in memory when you press the switch of the remote control unit. However, the memory page is not changed. The previously captured image is replaced with the new one.

Function to be selected	Operation
CAP/S PAGE <sup>b)</sup> (CAPTURE/SOURCE PAGE)	When the memory image is displayed, the source image appears when you press the switch of the remote control unit. When the source image is displayed, the image is captured in memory when you press the switch. The memory page is also changed. The captured image is not printed.
PRINT & PAGE	Starts to print when you press the switch if the image has been captured in the memory, and at the same time moves to the next memory page. If the image has not been captured in the memory page, the printer does not work correctly when you press the switch of the remote control unit.
SRC & CAP (SOURCE & CAPTURE)	When you press and hold down the switch of the remote control unit, the source image appears. When you release the switch, the image showing at the instant you release the switch is captured. The memory page is not changed.
SRC & C PAGE <sup>b)</sup> (SOURCE & CAPTURE PAGE)	When you press and hold down the switch of the remote control unit, the source image appears. When you release the switch, the image showing at the instant you release the switch is captured. Then, the memory page is changed to the next memory page. The captured image is not printed.

- a) When you use the remote control unit with this function, confirm that the source image is displayed on the video monitor. If not, press the SOURCE/MEMORY button so that the source image will be displayed. When multiple reduced images are being captured, after the last image is captured, the printer prints the captured image (or queues printing), then the printer goes to the next memory page.
- b) When multiple reduced images are being captured, after the last image is captured, the printer goes to the next memory page.

## Adjusting the Brightness of the Printer Window Display (Only for the UP-21MD)

When it is hard to read the contents of the printer window display, adjust the brightness using the menu.

- 1 Display the SYSTEM SETUP menu from the PRINTER SETUP menu.

```

SYSTEM SETUP      COL-S: 80
▶PRN SETUP :PRESS[>]
LCD-CNTR. : 7 .....|.....
BAUDRATE  : /24/48/9600
BEEP      : OFF/ON
IRE       : 100/11/12/13
SAVE USER: 1/2/3 [EXEC]
USER NAME : PRESS[>]

Q1 A           1           S

```

- 2 Select the LCD-CNTR. item, then adjust the brightness of the printer window display.

### Note

If you select the left end of the scale, OFF is displayed. In this case, no messages appear in the printer window display when the video monitor returns to the regular screen.

## Selecting Whether the Operation and Error Tones Sound

Whenever you press a button on the front panel or sub panel, the operation tone sounds (one time). When an error occurs, the alarm tone sounds (three times). You can turn these tones on and off using the menu.

- 1 Display the SYSTEM SETUP menu from the PRINTER SETUP menu.
- 2 Select the BEEP item, then select whether or not the operation and error tones sound by pressing the ← or → button.

When you want to	Selection
Sound the tones.	ON
Disable the tones.	OFF

## Setting the Baud Rate

When controlling the printer with a computer connected to the printer's RS-232C connector, select the appropriate baud rate. For details, contact your nearest Sony dealer.

- 1 Display the SYSTEM SETUP menu from the PRINTER SETUP menu.
- 2 Select the BAUD RATE item, then select the desired baud rate by pressing the  $\leftarrow$  or  $\rightarrow$  button.

Baud rate (bps)	Baud rate displayed on the menu. (The display changes from first two digit indication to four digit indication.)
1200	12 → 1200
2400	24 → 2400
4800	48 → 4800
9600	96 → 9600

## Displaying the Type and Remaining Amount of the Ink Ribbon

You can always display the type of the ink ribbon and the amount remaining on the video monitor.

### Note

Use the ribbon remaining display as a criterion. The correct amount remaining may not be displayed when you replace the ink ribbon that has been partially used. Also, when you load the ink ribbon and paper supplied with the printer, the display is not correct.

- 1 Display the OUTPUT SETUP menu.
- 2 Select the RBN REMAIN item, then select whether or not the type of ink ribbon and the amount remaining are to be displayed on the monitor.

When you want to	Setting
Display the type of ink ribbon and the amount remaining.	ON
Erase the information about the ink ribbon.	OFF

## Ink ribbon information

Type of ink ribbon  
When the ink ribbon runs out or is not loaded, the message "SET RIBBON" appears.

Number of printouts that can be made with the ribbon

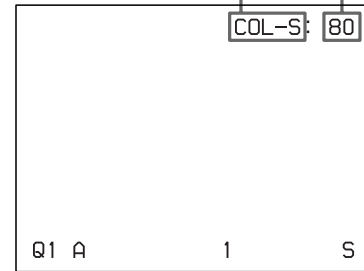

## Registering a User Set

You can store up to three settings of all the printer specifications set or adjusted by using the buttons or the menu, and store those settings as a user set. The printer retains these setting - even if you turn off the power. Thus, different operators can make printouts with different settings by recalling the appropriate user set. If the data of the recalled user set is modified, the printer operates according to the modified data. In such a case, the modified data remains effective until another user set is recalled on the PRINTER SETUP menu, even if you turn off the power.

After you finish all of the required settings, proceed as follows to register them as a user set.

### Note

If the user set is changed, all images stored in memory will be cleared.

- 1 Display the SYSTEM SETUP menu from the PRINTER SETUP menu.  
If you want to name a user set, go to step 2.  
If you do not want to name a user set, go to step 4.
- 2 Select the USER NAME item, then press the  $\rightarrow$  button.  
The USER NAME menu appears.

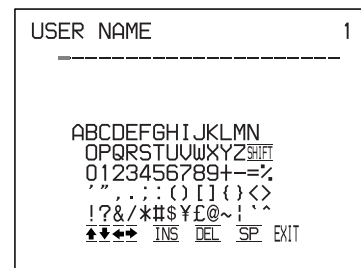

For detailed information on how to enter characters, see “Entering a Caption” on page 31.  
You can use up to 16 characters.

- 3** Select EXIT by pressing the ⏏, ⏏, ⏏ or ⏏ button on the USER NAME menu, then press the EXEC button.  
The user name is stored, and the SYSTEM SETUP menu appears again.
- 4** Select the SAVE USER item, then select the desired user set number.
- 5** Press the EXEC button.  
All data currently set and adjusted are registered in the user set number selected in step 4.  
When you name a user set in step 2, the user name is also registered at the same time.

The printer operates according to this registered data unless you recall another user set. Also, if you modify the settings, the modified data remains effective until another user set is recalled, even if you turn off the power.

#### **To make another user set**

Perform all required settings and adjustments using the menus, then register them with another user set number.

#### **To recall the user set and print**

Select the desired user set by using the LOAD USER item on the PRINTER SETUP menu, then press the EXEC button to execute the selected user set.  
The printer operates according to the recalled user set. If you modify the set value, the printer operates according to the modified data until you recall another user set.

#### **To retain the originally set values**

Example: Modify the settings made for user set 1. Retain the original settings of user set 1 and register the modified set values as user set 2.

- 1** Select user set 1 from the LOAD USER item on the PRINTER SETUP menu.
- 2** Press the EXEC button to execute the selected user set 1.
- 3** Modify the recalled set values.
- 4** Select 2 from the SAVE USER item on the SYSTEM SETUP menu.
- 5** Press the EXEC button.  
The set values, modified in step 3, are registered as user set 2.

#### **To copy the existing user set**

You can copy an existing user set to another user set number.

- 1** Select the source user set number from the LOAD USER item on the PRINTER SETUP menu.
- 2** Press the EXEC button to execute the selected user set.
- 3** Select the target user set number with SAVE USER on the SYSTEM SETUP menu.
- 4** Press the EXEC button.  
The set values of the source user set, selected in step 1, are copied to the target user set number selected in step 3.

# Precaution

## Safety

- Operate the printer using the power source specified in “Specifications” on page 58.
- Be careful not to damage the AC power cord by placing or dropping heavy objects on it; it is dangerous to use the unit with a damaged AC power cord.
- If you do not intend to use the unit for a long time, disconnect the AC power cord.
- Unplug the AC power cord by grasping the plug, not the cable itself.
- Do not disassemble the unit.
- Do not remove the cover. There is a danger of electric shock from the internal parts.
- Be careful not to spill water or other liquids on the unit, or to allow combustible or metallic material to enter the cabinet. If used with foreign matter in the cabinet, the unit is liable to fail, or present a risk of fire or electric shock.
- Ventilation holes are provided to prevent the unit from overheating. Be careful not to obstruct them with other units or by covering the unit with a cloth, etc.
- If the unit malfunctions or if a foreign body falls into the cabinet, disconnect the AC power cord immediately and consult your Sony service facility or your Sony dealer.

## Installation

- Avoid placing the unit in a location subject to:
  - mechanical vibration
  - high humidity
  - excessive dust
  - direct or excessive sunlight
  - extremely high or low temperatures
- Do not use other electronic equipment near the unit. The unit will not work properly in strong electromagnetic fields.
- Do not place a heavy object such as a monitor on the printer.

## Condensation

- If the printer is subject to wide or sudden changes in temperature, such as when it is moved from a cold room to a warm room or when it is left in a room with a heater that tends to produce large amounts of moisture, condensation may form inside the printer. In such cases the printer will probably not work properly,

and may even develop a fault if you persist in using it. If condensation forms, turn off the power and leave the printer to stand for at least one hour.

- If the printing pack is subjected to wide or sudden changes in temperature, condensation may form on the ink ribbon or paper. This will cause the printer to malfunction. Also, if the printing pack is used in this state, spots are likely to appear on the printout. Therefore, avoid storing the printing pack in locations subject to wide or sudden changes of temperature.
- To store a half-used printing pack, replace it in its original packing and reseal the package. If possible, keep the sealed printing pack in a cool, dark location. To subsequently use the printing pack, place it, in its sealed package, in a warm room for several hours. Doing so prevents condensation from forming when the printing pack is removed from its package.

## Location

To prevent internal heat built-up, leave enough room around the printer for air to circulate through the vents on the left hand side and top of the cabinet.

## Before Transporting the Printer

Before transporting the printer, use the following procedure to remove the supplied accessories and then put them back into their original packing. Transporting the printer with the supplied accessories still installed may cause malfunctions.

- 1 Remove the ink ribbon and the paper tray.
- 2 Secure the internal thermal head, as follows:
  - ① Turn on the printer.
  - ② Press the ⇐ and ⇒ cursor keys and the MENU button simultaneously.  
The printer operating tone sounds for about two seconds. For the UP-21MD, the message “TRANSPORT MODE” appears on the printer window display, too.
  - ③ When the printer operation tone stops sounding, turn off the power of the printer.

The thermal head is now secured.

### To release the thermal head

Turn on the printer again. The thermal head moves so that you can now install the ink ribbon again.



---

## Cleaning

### Cleaning the cabinet

Clean the cabinet, panel and controls with a soft dry cloth, or a soft cloth lightly moistened with a mild detergent solution.

#### Notes

- Be sure to turn off the power of the printer before cleaning.
- Do not use any type of solvent, such as alcohol or benzene, which may damage the finish.

### Cleaning the thermal head

Clean the thermal head with the thermal head cleaning cartridge (supplied) if the printout quality deteriorates, for example, when the white stripes begin to appear on the printout.

It is recommended that you clean the thermal head after every 10 packs of paper to keep the printout quality at its best.

- 1 Remove the paper tray and remove the paper.
- 2 Place the cleaning sheet in the paper tray so that the shiny surface faces down.

#### Notes

- Be sure to use the cleaning sheet supplied with the UPC-21L/21S color printing pack.
  - Do not reuse the old cleaning sheet.
- 3 Load the cleaning cartridge into the ribbon compartment, and then close the front panel. “CLEAN HEAD:PRESS[EXEC]” is displayed. If the ink ribbon is left in the ink ribbon compartment, remove the ink ribbon first, then load the cleaning cartridge. For detailed information on how to load, see “Loading an Ink Ribbon” on page 13.
  - 4 Press the EXEC button. The thermal head cleaning is started. While the head is being cleaned, “CLEAN HEAD:NOW CLEANING” is displayed. When cleaning has been completed, “CLEAN HEAD:FINISHED” is displayed.

---

## Recommended Ink Ribbon and Paper

Both paper and an ink ribbon are necessary for printing. Use the ink ribbon with the paper contained in the same package.

### UPC-21S Color Printing Pack

Contains color ink ribbon cartridge and paper.

Color ink ribbon: 3 rolls

Paper: 90 × 100 mm (5 3/4 × 8 3/8 inches) size paper, 1 package (80 sheets) × 3

### UPC-21L Color Printing Pack

Contains color ink ribbon cartridge and paper.

Color ink ribbon: 4 rolls

Paper: 100 × 144 mm (5 3/4 × 8 3/8 inches) size paper, 1 package (50 sheets) × 4

#### Note

If the paper has been exhausted, replace the ink ribbon together with the paper.

# Specifications

## Power requirements

- 100 to 120 V AC only, 50/60 Hz  
(for 100 to 120 V AC users)
- 220 to 240 V AC only, 50/60 Hz  
(for 220 to 240 V AC users)

## Power consumption

- About 1.8 A max. at 25°C  
(for 100 to 120 V AC users)
- About 1.0 A max. at 25°C  
(for 220 to 240 V AC users)

## Operating temperature

- 5°C to 35°C (41°F to 95°F)

## Operating humidity

- 20% to 80% (no condensation allowed)

## Storage and transport temperature

- 20°C to 60°C (-4°F to 140°F)

## Storage and transport humidity

- 20% to 90% (no condensation allowed)

## Dimensions

- About 212 × 125 × 395 mm (w/h/d)

- (8 3/8 × 5 × 15 5/8 inches)

## Mass

- About 6.5 kg (14 lb 5 oz)

## Printing system

- Dye transfer sublimation printing

## Printable pixels

- When using the UPC-21S and printing the full-image:
  - In NTSC mode: 1524 × 976 dots  
(when the H WIDTH and V WIDTH are set to 1016 and 488 on the WINDOW SETUP menu)
  - In PAL mode: 1524 × 1176 dots  
(when the H WIDTH and V WIDTH are set to 1016 and 588 on the WINDOW SETUP menu)
- When using the UPC-21L and printing the full-image:
  - In NTSC mode: 2032 × 1452 dots  
(when the H WIDTH and V WIDTH are set to 1016 and 488 on the WINDOW SETUP menu)
  - In PAL mode: 2032 × 1458 dots  
(when the H WIDTH and V WIDTH are set to 1016 and 588 on the WINDOW SETUP menu)

## Total gradation

- 256 levels each for yellow, magenta, and cyan

## Printing time

- When using the UPC-21S:
  - When PRN SPEED is set to HIGH on the PRINTER SETUP menu
  - In NTSC mode: Approximately 16 seconds
  - In PAL mode: Approximately 17 seconds
  - When PRN SPEED is set to NORMAL on the PRINTER SETUP menu

In NTSC mode: Approximately 24 seconds

In PAL mode: Approximately 27 seconds

When using the UPC-21L:

When PRN SPEED is set to HIGH on the PRINTER SETUP menu

In NTSC mode: Approximately 25 seconds

In PAL mode: Approximately 25 seconds

When PRN SPEED is set to NORMAL on the PRINTER SETUP menu

In NTSC mode: Approximately 40 seconds

In PAL mode: Approximately 40 seconds

## TV system

Selectable with the NTSC/PAL selector

In NTSC mode: NTSC/EIA standards

In PAL mode: PAL B.G.I. standards

## Input connectors

RGB SYNC (analog RGB signal)  
(only for the UP-21MD):

BNC connector × 4

RGB: 0.7 Vp-p, 75 ohm terminated

SYNC: 0.3 to 4 Vp-p, 75 ohm terminated, sync negative

SYNC ON G:

Automatic discrimination

S VIDEO (Separate luminance (Y) and chrominance (C) signals):

4-pin mini-DIN × 1

Y: 1 Vp-p, 75 ohm terminated, sync negative

C: For NTSC/EIA standards:  
0.29 Vp-p color burst, 75 ohm terminated

For PAL B.G.I. standards:  
0.3 Vp-p color burst, 75 ohm terminated

VIDEO (NTSC composite video signal for NTSC/EIA standards and PAL composite video signal for PAL B.G.I. standards):

BNC connector × 1

1 Vp-p, 75 ohm terminated, sync negative

AC IN (for power input)

## Output connectors

RGB SYNC (analog RGB signal)  
(only for the UP-21MD):

BNC connectors × 4

RGB: 0.7 Vp-p, 75 ohm terminated

SYNC: 1 Vp-p, 75 ohm terminated, sync negative  
 S VIDEO (Separate luminance (Y) and chrominance (C) signals):  
 4-pin mini-DIN × 1  
 Y: 1 Vp-p, 75 ohm terminated, sync negative  
 C: For NTSC/EIA standards: 0.29 Vp-p color burst, 75 ohm terminated  
 For PAL B.G.I. standards: 0.3 Vp-p color burst, 75 ohm terminated  
 VIDEO (NTSC composite video signal for NTSC/EIA standards and PAL composite video signal for PAL B.G.I. standards) BNC connector × 1  
 1 Vp-p, 75 ohm terminated, sync negative

**Controls connectors**

REMOTE 1: special mini jack × 1  
 For RM-5500 Remote Control Unit (not supplied)  
 REMOTE 2 (automatic printing connector): Stereo mini jack: × 1  
 For RM-91 Remote Control Unit (See “Assigning Functions to the Remote Control Unit” on page 52.)  
 RS-232C (Computer control interface):  
 D-SUB 25-pin connector × 1  
 Output: 5-kilohm load  
 Typical ± 8 V  
 Input: 5-kilohm load  
 High level 5 to 15 V  
 Low level -5 to -15 V

**Supplied accessories**

Color printing pack (1)  
 Paper tray (1)  
 AC power cord (1)  
 Warranty card (1) (for the customers in the U.S.A. and Canada only)  
 CD-ROM (for the customers in the Europe only)  
 Thermal head cleaning cartridge (1)  
 Instructions For Use (1)

**Optional accessories**

UPC-21L Color Printing Pack  
 UPC-21S Color Printing Pack

**Medical Specifications**

Protection against electric shock:  
 Class I  
 Protection against harmful ingress of water:  
 Ordinary  
 Degree of safety in the presence of flammable anesthetics or oxygen:  
 Not suitable for use in the presence of flammable anesthetics or oxygen  
 Mode of operation:  
 Continuous

**Using the automatic printing capabilities (REMOTE 2)**

If you send remote control pulse signals as illustrated through the REMOTE 2 connector, the printer can be remotely controlled according to the remote control setting. (See page 52.)

Turn on the power of the printer and display the source image on the monitor screen. Send a remote control pulse signal at the timing shown below.

The timing depends on the setting on item IMMED. CAP of the FUNCTION SETUP menu.

**Note**

The remote control pulse signal examples introduced here are one example of typical operation timing. The timing may be affected due to the memory page selected and print type.

**CAPTURE timing pulse for REMOTE 2:**  
 REMOTE 2 connector pin assignment:

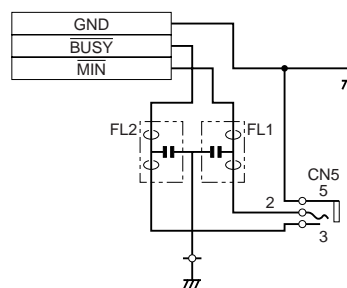
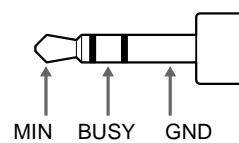

Miscellaneous

**When IMMED. CAP. is set to OFF:**

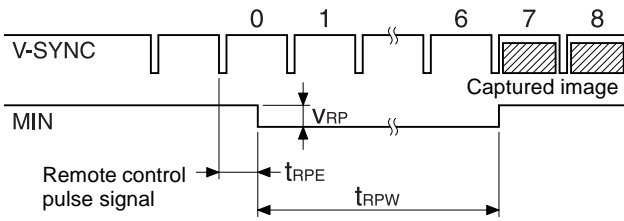

Notation	Parameter	MIN	TYP	MAX	Unit	Remarks
tRPE	Time within which a remote control pulse should be cleared to zero.	3	-	12	msec	-
tRPW	Length of a remote control pulse	100	-	-	msec	-
VRP	Amplitude of a remote control pulse	-	-	5	V	This value is based on the TTL standard.

The above example shows that the images at the seventh and eighth positions are captured. However, images at other positions could be captured depending on the printer mode and printer settings.

**Note**

When AUTO LIVE of the FUNCTION SETUP menu is set to OFF, the memory image is displayed on the screen after the image is captured in memory. In such a case, whenever you capture an image, press the SOURCE/MEMORY button so that the source image appears on the video monitor. Displaying the memory image does not allow you to capture the image with the correct timing.

**When IMMED. CAP. is set to ON:**

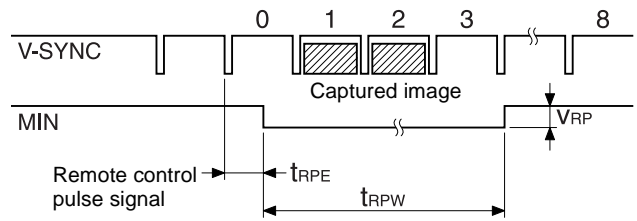

Notation	Parameter	MIN	TYP	MAX	Unit	Remarks
tRPE	Time within which a remote control pulse should be cleared to zero.	3	-	10	msec	-
tRPW	Length of a remote control pulse	100	-	-	msec	-
VRP	Amplitude of a remote control pulse	-	-	5	V	This value is based on the TTL standard.

**Note**

This mode is effective only when the source image is displayed on the monitor screen. If the memory image is displayed, the image will not be captured even if the pulse is sent to the printer. Be sure to display the source image when sending the pulse.

Design and specifications are subject to change without notice.

# Error/Warning Messages

There are two kinds of messages: error messages and warning messages. This section lists these messages together with their possible causes and remedies. Note the messages and act accordingly.

## Error Messages

If a problem occurs, the ALARM lamp lights in orange and an error message stating the problem appears on the monitor and in the printer window display.

In the error message introduced in the following tables, “nn” indicates the number or symbol displayed in the actual message.

Error message		Possible causes and remedies
On the video monitor	On the printer window display (only for the UP-21MD)	
SET RIBBON AND PAPER	SET RIBBON SET PAPER	An ink ribbon and paper are not loaded. →Load the ink ribbon and paper. (See pages 13 and 14.)
SET PAPER	SET PAPER	<ul style="list-style-type: none"> <li>Paper has been exhausted. →Load the paper. (See page 14.) Also, replace the ink ribbon.</li> <li>The paper tray is not installed. →Install the paper tray. (See page 15.)</li> </ul>
SET RIBBON	SET RIBBON	The ink ribbon is not loaded. →Load the ink ribbon. (See page 13.)
RIBBON END	RIBBON END	<ul style="list-style-type: none"> <li>The ink ribbon has been exhausted. →Replace the old one with a new ink ribbon. (See page 13.) (The ink ribbon cannot be reused.) In this case, if the white paper is ejected. Discard this paper.</li> <li>The ink ribbon has torn. →Repair the torn ink ribbon. (See page 14.)</li> </ul>
REMOVE PRINTS	REMOVE PRINTS	The maximum number of printouts has accumulated on the paper tray. →Remove the printouts. Printing starts again.
REMOVE PAPER TRAY	REMOVE PAPER TRAY	The paper jams around the paper tray. →Remove the paper tray and pull out any jammed paper. (See page 64.)
PAPER MISMATCH	PAPER MISMATCH	The ink ribbon and paper are not compatible. →Use the ink ribbon and paper contained in the same package. (See page 57.)
CLOSE DOOR	CLOSE DOOR	The front door is open. →Close the front door.
CHECK RIBBON nn	CHECK RIBBON nn	<ul style="list-style-type: none"> <li>The ink ribbon has torn. →Repair the torn ink ribbon. (See page 14.)</li> <li>An ink ribbon that can not be used with this printer has been loaded. →Load the appropriate ink ribbon. (See page 57.)</li> </ul>
CHECK PAPER:LOAD nn	CHECK PAPER nn LOAD	Paper has jammed inside the printer. →Remove any jammed paper from the printer. (See page 64.)
CHECK PAPER: EJECT nn	CHECK PAPER nn EJECT	
MECHA TROUBLE:HEAD nn	MECHA TROUBLE nn HEAD	Some trouble occurs in the printer. →Turn off the printer once. Then turn on the printer again and try to operate the printer.
MECHA TROUBLE: PROCESS nn	MECHA TROUBLE nn PROCESS	If the error message appears again, contact your Sony service facility or your Sony dealer to clear the error status.
MECHA TROUBLE: SENSOR nn	MECHA TROUBLE nn SENSOR	

Miscellaneous

## Warning Messages

In case of a warning, only warning messages appear. The ALARM lamp does not light.

Warning message		Possible causes and remedies
On the video monitor	On the printer window display (only for the UP-21MD)	
HIT ANY KEY	HIT ANY KEY	This message appears when the remote control unit is used in CAP-STOP (CAPTURE STOP) mode and when the printer stops capturing images once images have been captured to all memory pages (to the last point of the last memory page). → Press any button. Printer operation is enabled after this.
INPUT MISMATCH	INPUT MISMATCH	<ul style="list-style-type: none"> <li>The TV system of the signal input from the source equipment (VTR, video camera and so on) is not compatible with the TV system of your printer. → Check the signal of the TV system and input the correct one.</li> <li>→ Check the setting of the NTSC/PAL selector on the rear panel. (See page 10)</li> <li>A signal other than a video signal (such as an audio signal, etc.) is input. → Input the correct video signal.</li> </ul>
NO INPUT	NO INPUT	<ul style="list-style-type: none"> <li>The printer is not receiving an input signal from equipment corresponding to the input selected on the INPUT SETUP menu. → Check the input signal selected on the INPUT SETUP menu. (See page 15.)</li> <li>→ Check whether the video equipment is outputting a video signal in playback mode.</li> <li>→ Check that the connections between the signal source equipment and the printer are secure. (See page 10.)</li> </ul>
NO IMAGE	NO IMAGE	The image is not captured in memory. → Capture the image in memory then start printing. (See page 17.)
PRINTING MEMORY	PLEASE WAIT NOW PRINTING	In the selected memory page, the captured image is being printed or queued. → Retry the operation once the printer finishes printing.
HEAD IN COOLING	PLEASE WAIT HEAD IN COOLING	The thermal head has overheated. → Leave the printer until the head cools down and this message disappears. The printer starts printing automatically.

# Troubleshooting

## If Damage is Suspected

The following troubleshooting checks will help you correct the most common problems you may encounter with your unit. Before proceeding with these trouble checks, first check that the power cord is firmly connected. Should the problem persist after you have applied the remedy, unplug the unit and contact your Sony dealer or local authorized Sony service facility.

Symptoms	Possible causes and remedies
Nothing appears on the video monitor even if you press any of the operation buttons.	<ul style="list-style-type: none"> <li>The POWER switch of the printer is not set to ON. →Set the POWER switch of the printer to ON.</li> <li>The POWER switch of the video monitor is not set to ON. →Set the POWER switch of the monitor to ON.</li> <li>Connections may not be correct. →Check connections and rectify, if necessary. (See page 11.)</li> </ul>
No message appears on the regular screen.	An incorrect signal is input. →Select another input signal on the INPUT SETUP menu. (See page 15.) Or, set the connected video equipment to playback mode, if it is currently set to another modes such as stop mode.
No message or image appears on the regular screen.	<ul style="list-style-type: none"> <li>If an image captured in memory appears when the SOURCE/MEMORY button is pressed, SOURCE on the OUTPUT SETUP menu is set to THRU. →Change the SOURCE setting to EE. (See page 44.)</li> <li>When the menu is displayed by pressing the MENU button, the DISPLAY setting of the video monitor is set to OFF. →Set the DISPLAY setting to ON by pressing the DISPLAY button. (See page 36.)</li> </ul>
No message appears on the printer window display. (Only for the UP-21MD)	<ul style="list-style-type: none"> <li>The contrast of the printer display window is not set correctly. →Adjust the brightness of the printer window display using the LCD. CNTR. item on the SYSTEM SETUP menu. (See page 53.)</li> <li>The contrast of the printer display window is set to OFF. →Adjust the brightness of the printer window display using the LCD. CNTR. item on the SYSTEM SETUP menu. (See page 53.)</li> </ul>

Symptoms	Possible causes and remedies
The printer does not print.	<ul style="list-style-type: none"> <li>An error message appears on the display. →Perform the steps described in “Error/Warning Messages” on page 61.</li> <li>Paper that cannot be used with this printer has been loaded. →Load the correct paper. Use only ink ribbons and paper for this printer. (See page 57.)</li> <li>The paper is not loaded correctly. →Check which side of the paper is the printing side, then load the paper again. (See page 14.)</li> </ul>
A black line appears on the printout.	Any portion for which there is no signal is printed in black. →Adjust the image area to be printed. (See page 47.) Then, capture a new image and print it.
The printer produces a printout with a black frame.	Any portion for which there is no signal is printed in black. →Adjust the image area to be printed. (See page 47.) Then, capture a new image and print it.
The printed image is partially cut out.	Only part of the video signal has been stored. →Adjust the image area to be printed. (See page 47.) Then, capture a new image and print it.
The printout is blurred.	A quickly moving image has been stored. →Set the memory mode to FIELD by using the MEMORY FRM/FLD item on the LAYOUT SETUP menu, then print it. (See page 24.)
The printout color is very pale.	The paper is not loaded correctly. →Check which side of the paper is the printing side, then load the paper again. (See page 14.)
The ink ribbon cannot be loaded.	<ul style="list-style-type: none"> <li>You may be trying to load an ink ribbon that can not be used with this printer has been loaded. →Load the appropriate ink ribbon. (See page 57.)</li> <li>The thermal is secured. →Turn on the printer. The thermal head moves so that you can now install the ink ribbon. (See page 56.)</li> </ul>
The blank paper is ejected even if you press the PRINT button and RIBBON END message appears.	The ink ribbon has been exhausted. Do not reuse the ejected blank paper. →Replace the ink ribbon. (See page 13.)

## If the Paper Jams

If the paper jams after you press the PRINT button, remove the jammed paper following the steps below.

- 1** Remove the paper tray.  
If any printouts have been ejected onto the paper tray and have accumulated on the paper tray, remove them before removing the paper tray.

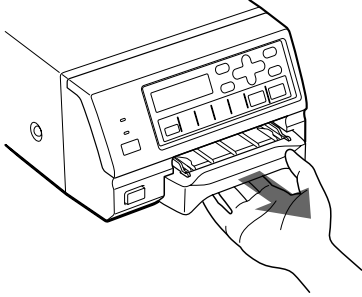

- 2** Check whether any paper is jammed inside the printer. If you find a jammed sheet, slowly pull it straight out.

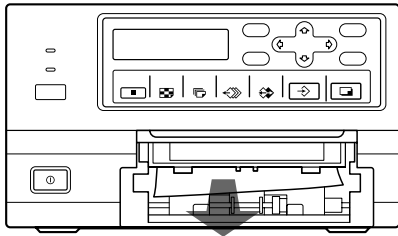

- 3** Load the paper into the paper tray correctly.

Set the paper securely under the tabs.

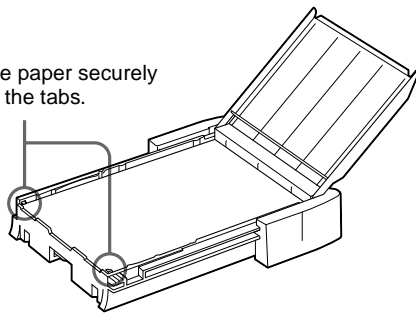

### Notes

- Do not reuse the jammed paper. Discard that paper.
  - Use only paper recommended in this manual.
- 4** Re-insert the removed paper tray.



# Index

- A**
  - About This Manual 4
  - Accessories
    - ink ribbon and paper 9
    - paper tray 9
    - power cord 9
  - Adjusting the color and picture quality
    - adjusting the color balance 48
    - adjusting the printout color 45
    - compensating for the input signals 43
    - eliminating the black lines
      - produced on printouts 47
    - matching the video monitor color to the printer color 44
- B**
  - Blur
    - checking blur from the memory image 29
    - eliminating the blur 17
- C**
  - Caption
    - CAPTION menu 31
    - entering 31
  - Cleaning
    - cabinet 57
    - thermal head 57
  - COLOR ADJUST menu 45
  - COLOR BALANCE menu 48
  - Connections
    - connecting the video monitor 11
    - connecting video equipment 10
    - for enabling remote control 12
- D**
  - Deleting the images stored in memory pages
    - deleting all images stored in the memory 35
    - deleting images in a certain memory page 36
    - setting the function of the CLEAR button 35
  - Display
    - erasing the screen display on the video monitor 36
    - type and remaining amount of the ink ribbon 54
- E**
  - Eliminating the blur 17
  - Error messages 61
- F**
  - Full-size image printout
    - making 17
    - setting 25
  - FUNCTION SETUP menu 27, 35, 52
- I**
  - Ink ribbon
    - loading 13
    - notes on storing 14
  - INPUT SETUP menu 15, 43
  - Input signal 15
  - Introduction 4
- L**
  - LAYOUT SETUP menu 24, 26
  - LOAD COLOR number
    - recalling 46
    - selecting 45
    - storing 46
  - Location and function of parts and controls
    - front panel 5
    - monitor display 7
    - rear panel 6
- M**
  - Memory mode
    - field mode 23
    - frame mode 23
    - selecting 24
  - Memory page
    - about the memory page 24
    - selecting 25
  - Menu
    - basic menu operation 40
    - CAPTION menu 31
    - COLOR ADJUST menu 45
    - COLOR BALANCE menu 48
    - FUNCTION SETUP menu 27, 35, 52
    - INPUT SETUP menu 15, 43
    - LAYOUT SETUP menu 24, 26
    - menu tree 39
    - OUTPUT SETUP menu 11, 44, 54
    - PRINTER SETUP menu 19, 21, 27, 29, 47
    - sub menus 42
    - SYSTEM SETUP menu 43, 53,
- O**
  - 54
  - WINDOW SETUP menu 47
  - Menu tree 39
  - Messages
    - error messages 61
    - warning messages 62
- P**
  - Operation 17
  - OUTPUT SETUP menu 11, 44, 54
  - Paper
    - loading 14
    - notes on storing 15
  - Paper jams 64
  - Precaution
    - before transporting the printer 56
    - condensation 56
    - installation 56
    - safety 56
  - Preparation 9
  - PRINTER SETUP menu 19, 21, 27, 29, 47
  - Printing
    - capturing another image while printing 22
    - confirming on the video monitor 29
    - if a black line appears on the printout 19, 47
    - if the captured image is blurred 17
    - if the color quality of the printouts is not satisfactory 19
    - if the paper runs out during printing 21
    - if the printer does not print 18
    - if the printout is blurred 29
    - making a printout with multiple reduced images 28
    - making a printout with white borders 30
    - making full-size image printouts 17
    - making multiple copies of identical printouts 20
    - making printouts at high speed 19
    - making printouts with a caption 31
    - making printouts with the desired user set number 19
    - selecting the printout type 25
- Printing pack
  - adjusting the color balance 48
  - available printing pack 57
- Printout quality

- adjusting the printout color 45
- compensating for the input signal 43
- eliminating the blur 17
- Printout quantity setting 20
- Printouts
  - note on storing 19
  - variations 23

## R

- Remote control
  - using the automatic printing capabilities 59
- Remote control unit
  - using as a wired unit 12
  - using as a wireless unit 12

## S

- Setting up the printer on the menu
  - adjusting the brightness of the printer window display 53
  - assigning the function to the remote control unit 52
  - displaying the type and remaining amount of the ink ribbon 54
  - functions that can be set on menu 38
  - selecting whether the operation tone and error tones sound 53
  - setting the baud rate for the computer communication 54
- Specification 58
- System overview 4
- SYSTEM SETUP menu 43, 53, 54

## T

- Thermal head
  - cleaning 57
  - releasing 56
  - securing 56
- Troubleshooting 63

## U

- User set
  - recalling 19, 55
  - registering 54

## W

- Warning messages 62
- WINDOW SETUP menu 47

